

Carcinogenic Mechanism of TCE and Its Metabolites, Dichloroacetic Acid and Trichloroacetic Acid: DNA Methylation.

Michael A. Pereira
Professor of Medicine
Division of Hematology and Oncology
Ohio State University
College of Medicine and Public Health
300 West Tenth Avenue, 1148B CHRI
Columbus, OH 43210
Phone # (614)-293-6864
Fax: (614)-293-3333
e-mail: pereira-1@medctr.osu.edu

Two Types of Alterations in DNA Methylation found during Carcinogenesis

- 1. DNA hypomethylation.**
 - 2. Hypermethylation of tumor suppressor genes.**
-

DNA Hypomethylation

- 1. Found early in all solid tumors; even in normal appearing tissue at risk of cancer and in precancerous lesions (foci).**
 - 2. There can be a 30-60% decrease in total extent of DNA methylation.**
 - 3. DNA hypomethylation is important because it can result in**
 - a. decreased binding of methylated DNA-binding proteins,**
 - b. alterations in the binding and /or recruitment of transcription factors and enzymes involved in histone modifications,**
 - c. increased histone acetylation (increased expression of genes),**
 - d. chromosomal instability, and**
 - e. hypermethylation of tumor suppressor genes.**
-

DNA Methylation in Normal Tissue and Tumors

Normal Tissue

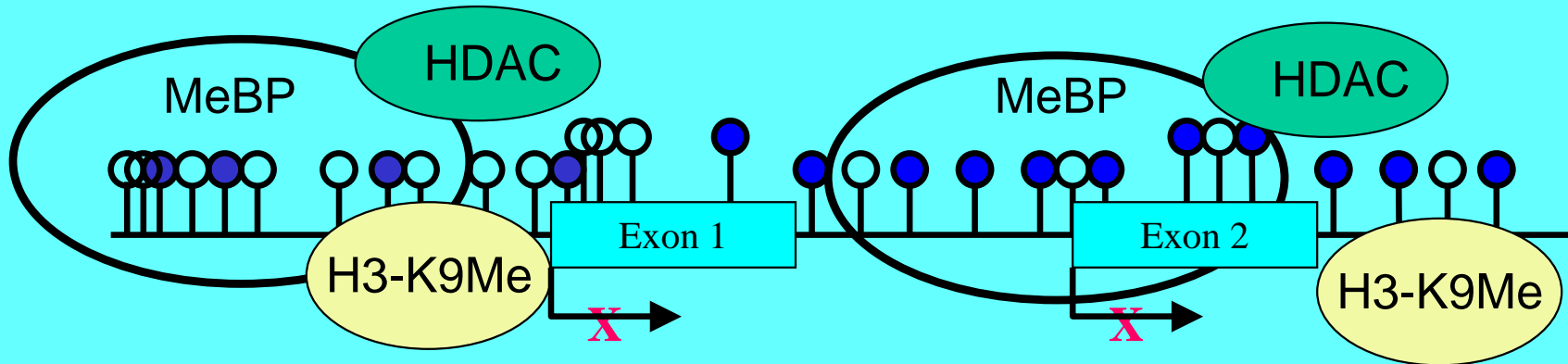

Tumor

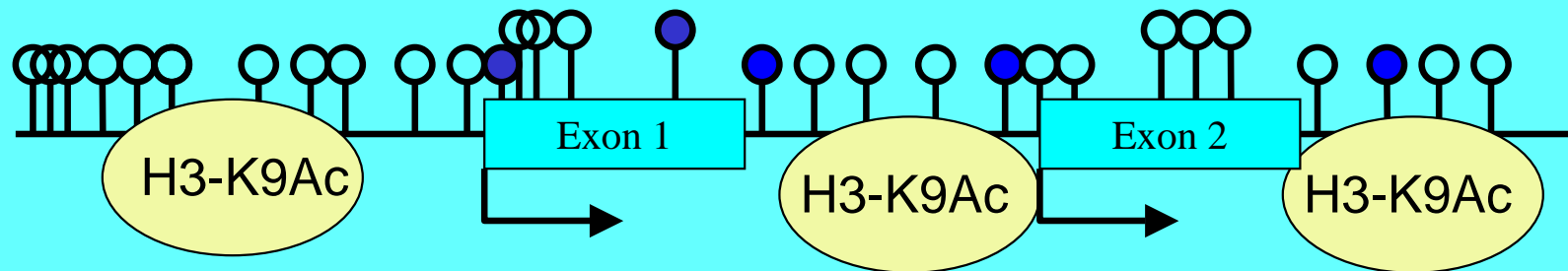

○ = Cytosine ● = 5-Methylcytosine

Hypermethylation of Tumor Suppressor Genes

- 1. CpG islands in exon-1 and its upstream promoter region that are unmethylated in normal tissue become hypermethylated in tumors.**
 - 2. Usually found at a later stage than DNA hypomethylation, although can be found in normal tissue at risk of cancer and in precancerous lesions (foci).**
 - 3. A major mechanism for the down-regulation of the mRNA expression of tumor suppressor genes in cancer.**
-

Methylation of Tumor Suppressor Genes in Normal Tissue and Tumors

Normal Tissue

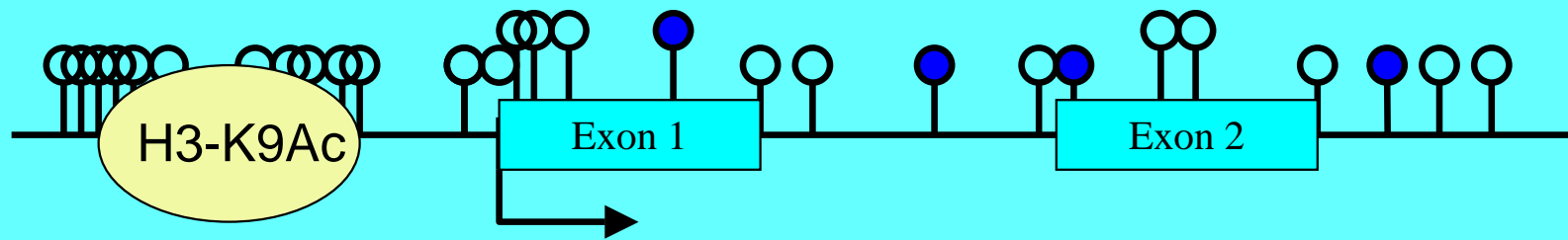

Tumor

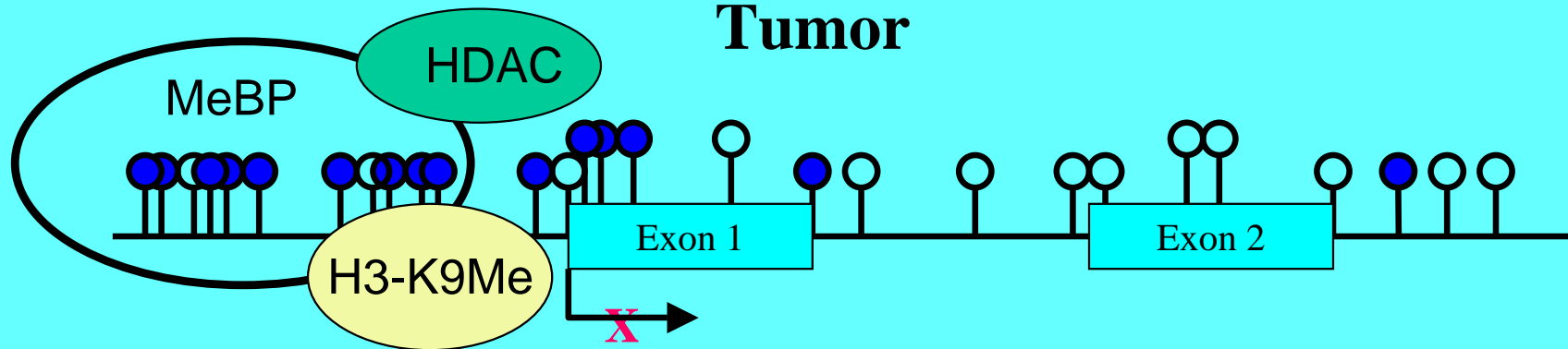

○ = Cytosine ● = 5-Methylcytosine

DNA Hypomethylation induced by DCA, TCA and TCE: Carcinogenic Mechanism

- 1. DCA, TCA and TCE induce DNA hypomethylation within days. Other nongenotoxic mouse liver carcinogens also induce DNA hypomethylation, i.e. THM, Wy-14,643, 2,4-dichlorophenoxy-acetic acid, dibutyl phthalate, gemfibrozil and phenobarbital.**
 - 2. Mouse liver tumors induced/promoted by DCA and TCA contain DNA hypomethylation. Upon cessation of exposure, DNA hypomethylation in DCA- but not in TCA-promoted liver tumors is reversible correlating with the regression of DCA but not TCA-promoted tumors upon cessation of exposure.**
 - 3. Methionine prevents DNA hypomethylation induced by DCA TCA, TCE and Wy-14,643. Chloroform prevents DCA but not TCA-induced DNA hypomethylation in the liver.**
-

DNA Hypomethylation induced by DCA, TCA and TCE: Carcinogenic Mechanism

- 4. Methionine and chloroform prevent DCA-induced mouse liver tumors and foci. Chloroform does not prevent TCA induced liver tumors. Thus, prevention of liver tumors by methionine and chloroform correlated with their prevention of DNA hypomethylation.**
 - 5. Chloroform increases DCA but not TCA-induced DNA hypomethylation in mouse kidney and increases only DC-but not TCA-promoted kidney tumors.**
 - 6. DNA hypomethylation could be used as a biomarker for the effect of route of administration and for cancer chemoprevention.**
 - 7. DNA hypomethylation decreases the extent to which histone H3 is acetylated.**
-

Mechanism of TCE, DCA and TCA Carcinogenic Activity

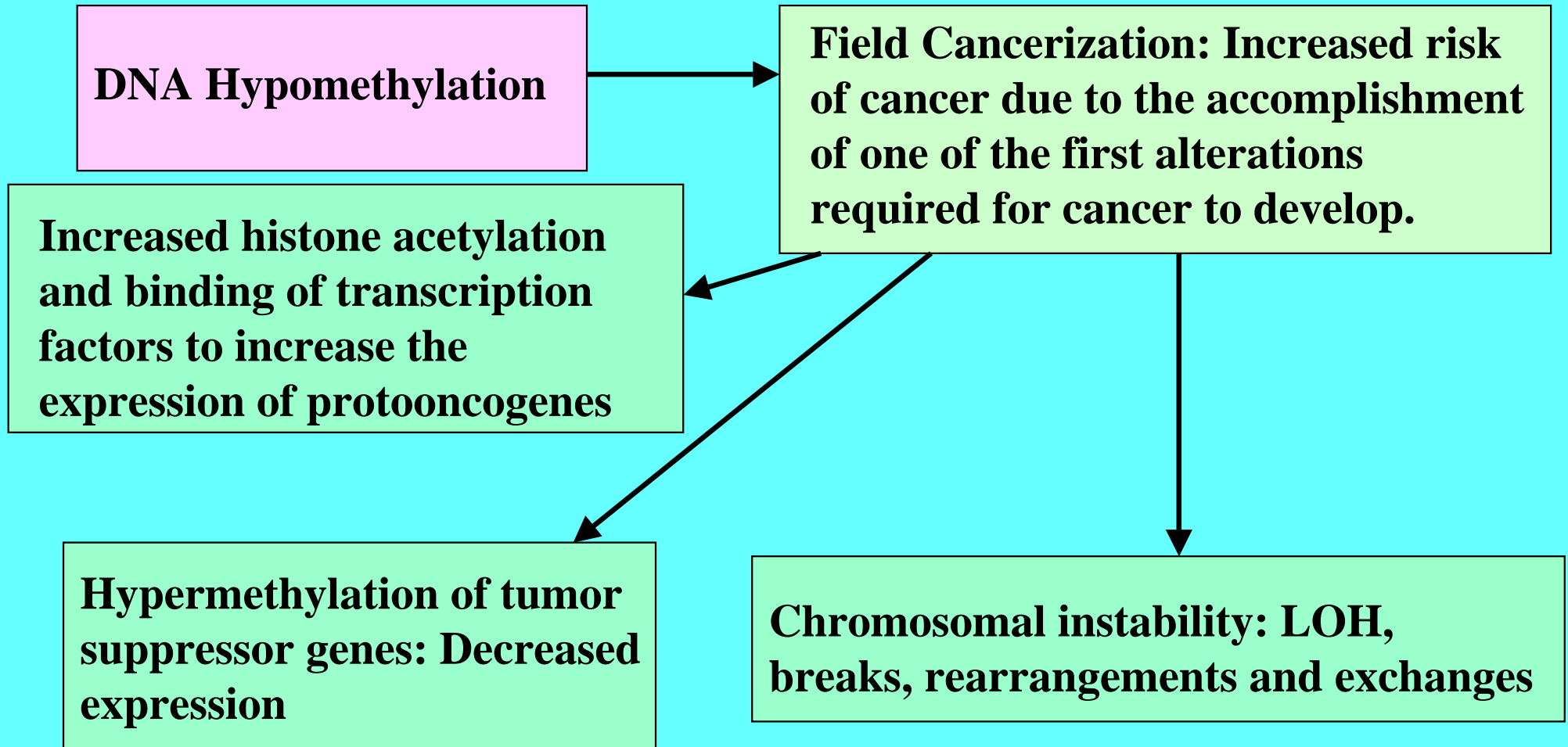

DNA Hypomethylation in DCA and TCA-induced Mouse Liver Tumors

1. DCA tumors regress after termination of exposure. In contrast, TCA tumors do not regress.
2. Pereira, M. A. and Phelps, J.B. (1996). Promotion by dichloroacetic acid and trichloroacetic acid of methylnitrosurea-induced cancer in the liver of female B6C3F1 mice. Cancer Letters, 102: 133-141.

Pereira, M. A. (1996). Carcinogenic activity of dichloroacetic acid and trichloroacetic acid in the liver of female B6C3F1 mice. Fundam. Appl. Toxicol., 31: 192-199.

Tao, L., Kramer, P.M., Ge, R., and Pereira, M.A. (1998) Effect of Dichloroacetic Acid and Trichloroacetic Acid on DNA Methylation in Liver and Tumors of Female B6C3F1 Mice. Toxicol. Sciences, 43: 139-144.

DNA Methylation in DCA-Treated Mice

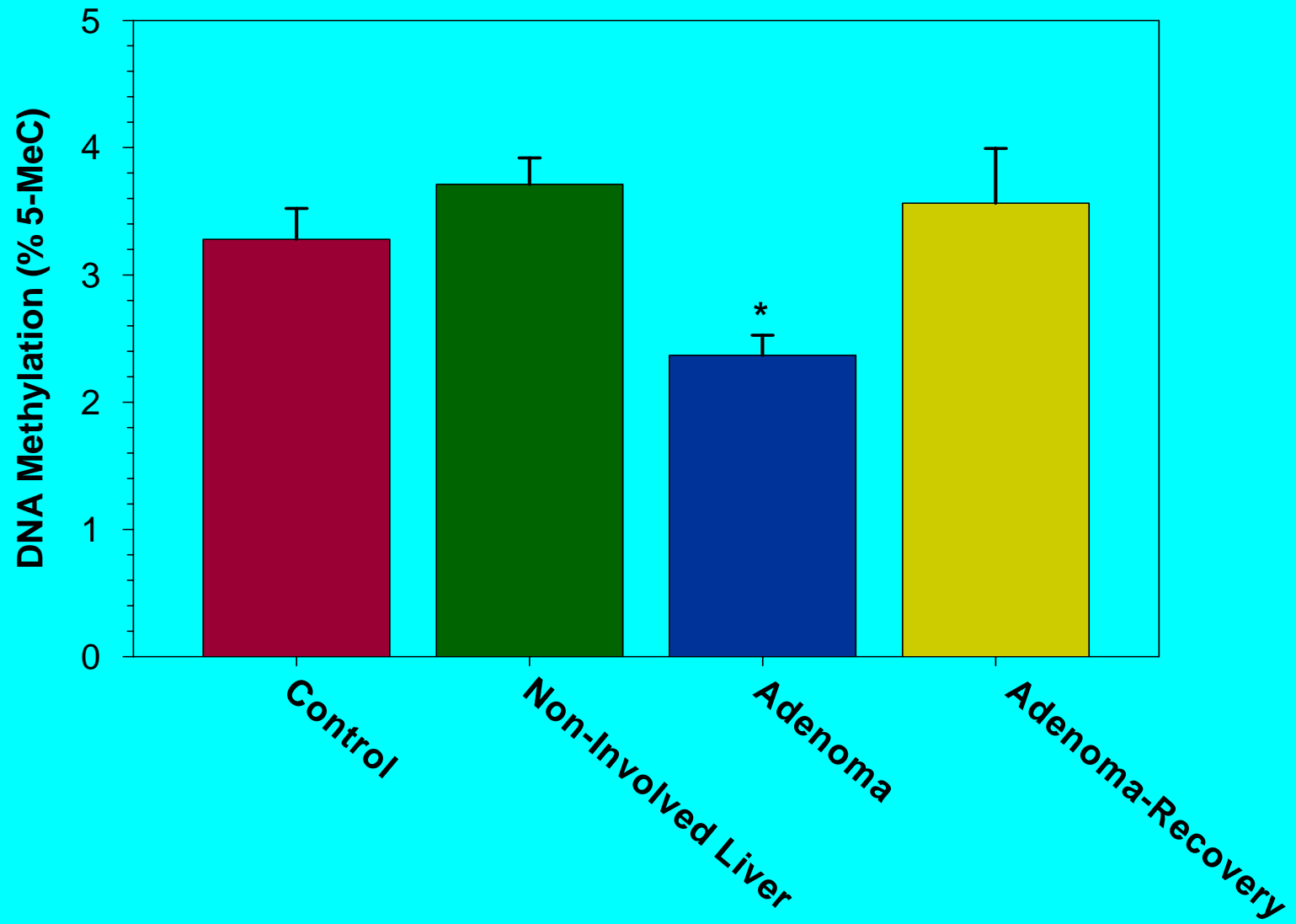

DNA Methylation in TCA-Treated Mice

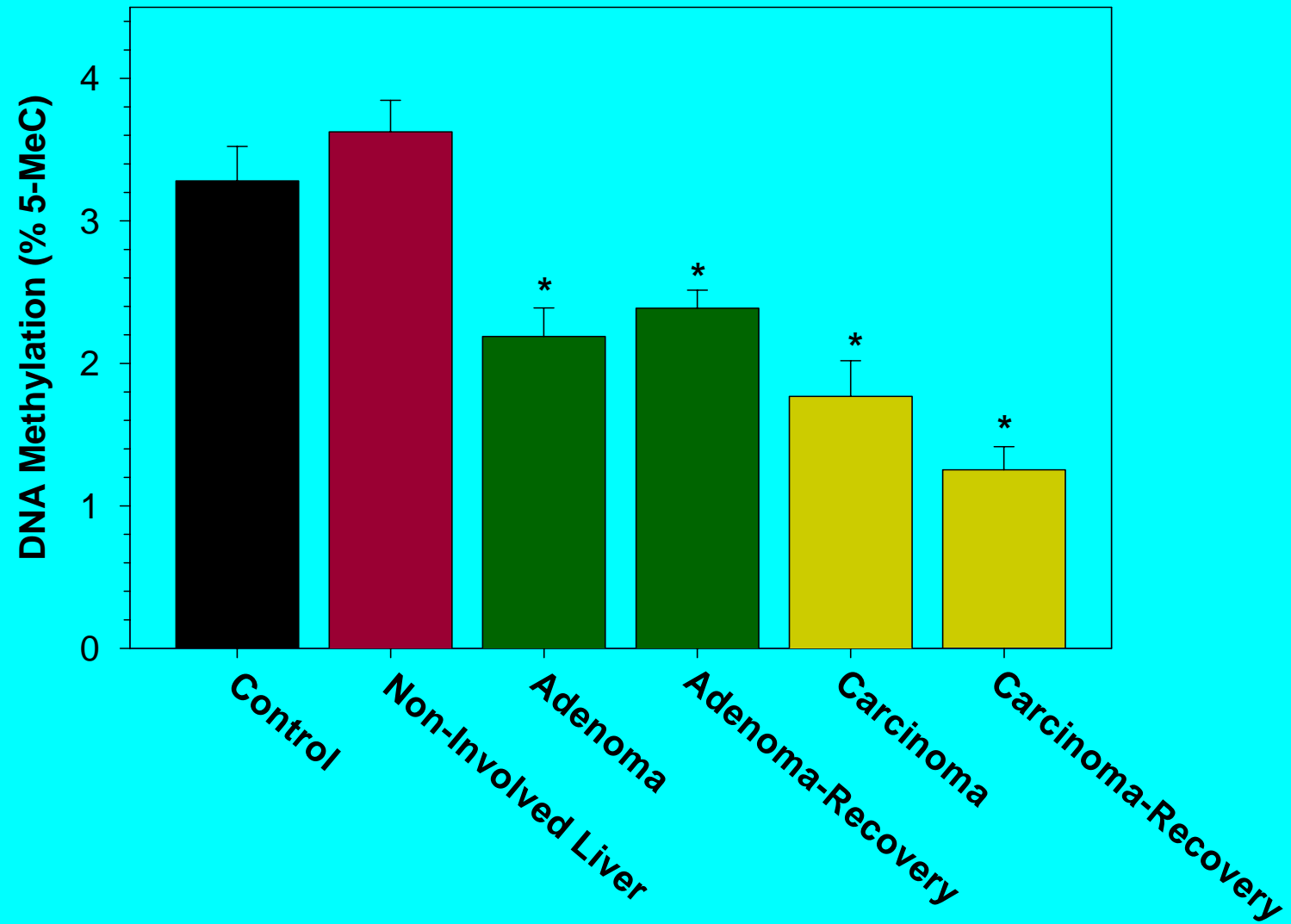

Correlation between the Ability of DCA and TCA to induce DNA Hypomethylation and Their Ability to induce Mouse Liver Tumors: Prevention by Methionine

Pereira, M.A., Wang, W., Kramer, P.M., and Tao, L. (2004). Prevention by Methionine of Dichloroacetic Acid-induced Liver Cancer and DNA Hypomethylation in Mice. Toxicological Sciences. 77:243-248.

Ge, R., Yang, S., Kramer, P.M., Tao, L. and Pereira, M.A. (2001) The Effect of Dichloroacetic Acid and Trichloroacetic Acid on DNA Methylation and Cell Proliferation in B6C3F1 Mice. J. Biochem. Molecul. Toxicol. 15: 100-106.

Tao, L., Yang, S., Xie, M., Kramer, P.M. and Pereira, M.A. (2000) Hypomethylation and Overexpression of *c-Jun* and *c-Myc* Protooncogenes and Increased DNA Methyltransferase Activity in Dichloroacetic Acid and Trichloroacetic Acid-Promoted Mouse Liver Tumors. Cancer Letters 158: 185-193.

Tao, L., Ge, R., Xie, M., Kramer, P.M. and Pereira, M. A. (2000) Effect of Trichloroethylene and Its Metabolites, Dichloroacetic Acid and Trichloroacetic Acid on the Methylation and Expression of *c-Jun* and *c-Myc* Protooncogenes in Female B6C3F1 Mouse Liver: Prevention by Methionine. Toxicol. Sci. 54: 399-407.

Dose-Response for the Effect of Methionine on DCA, TCA and TCE-induced Hypomethylation of the c-Jun and c-Myc Genes

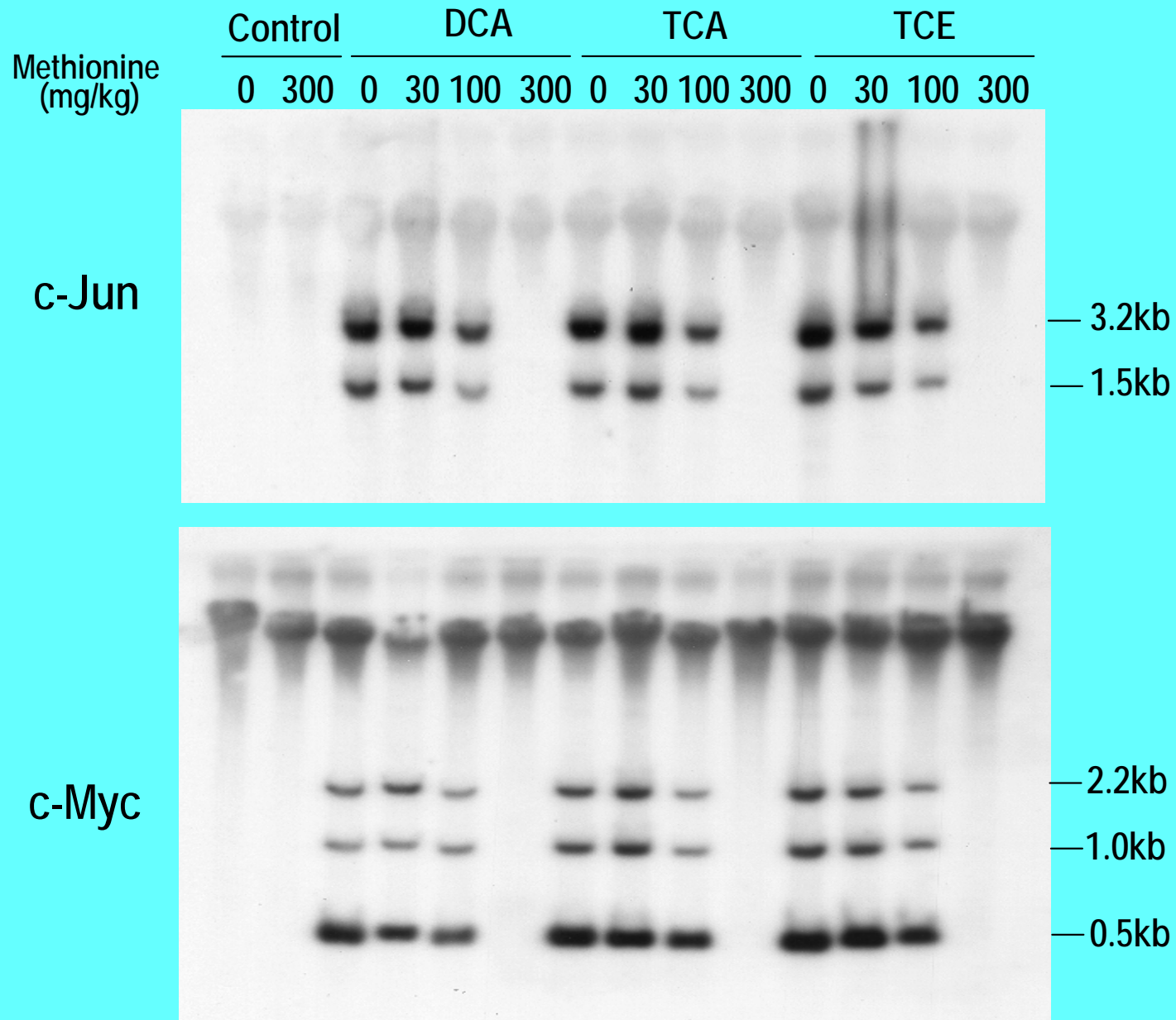

Protocol for the Effect of Methionine on DCA-induced Liver Tumor in Female B6C3F1 Mice

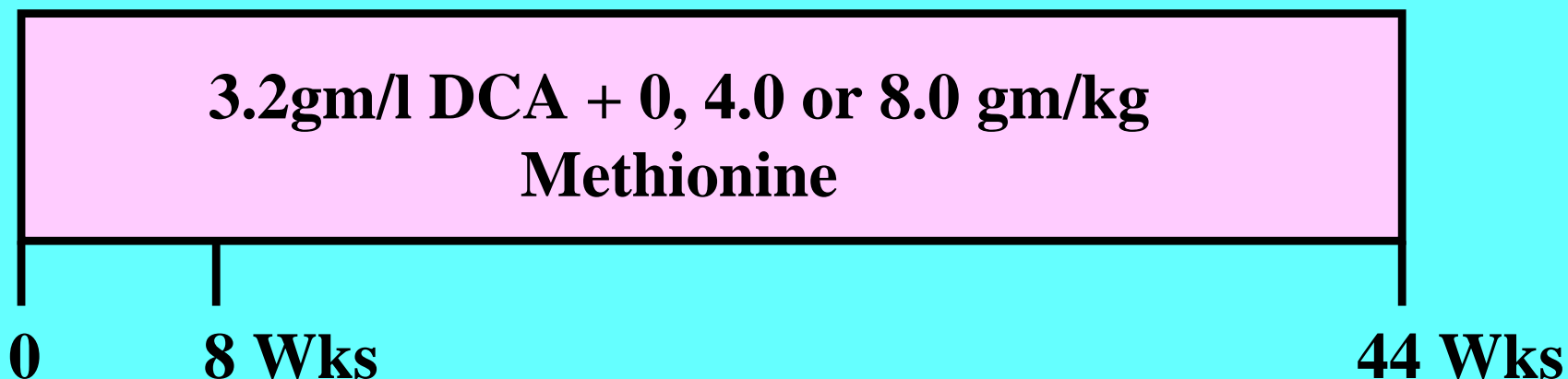

Effect of Methionine on DCA-induced Foci and Adenomas

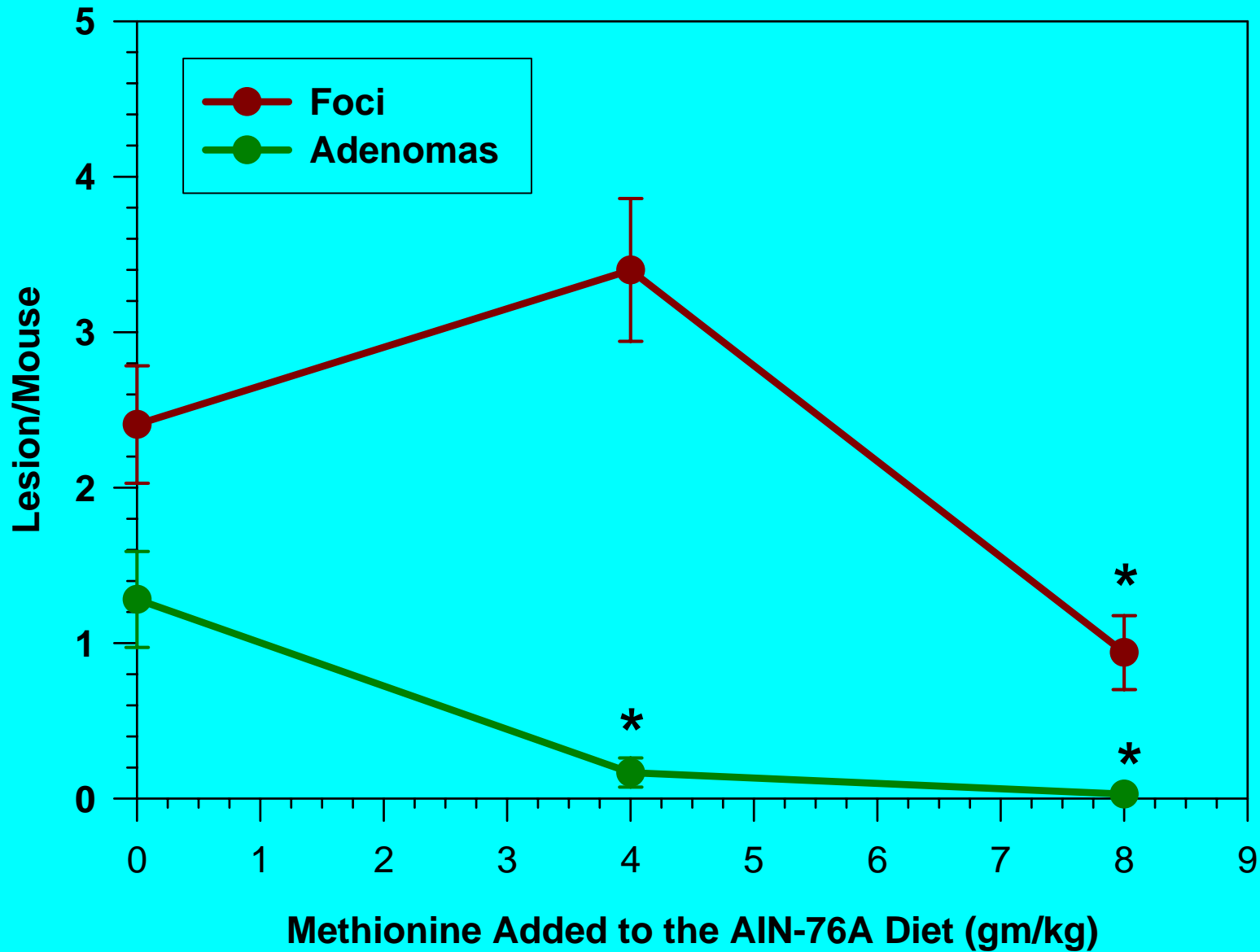

Effect of Methionine on the Liver/Body Weight Ratio

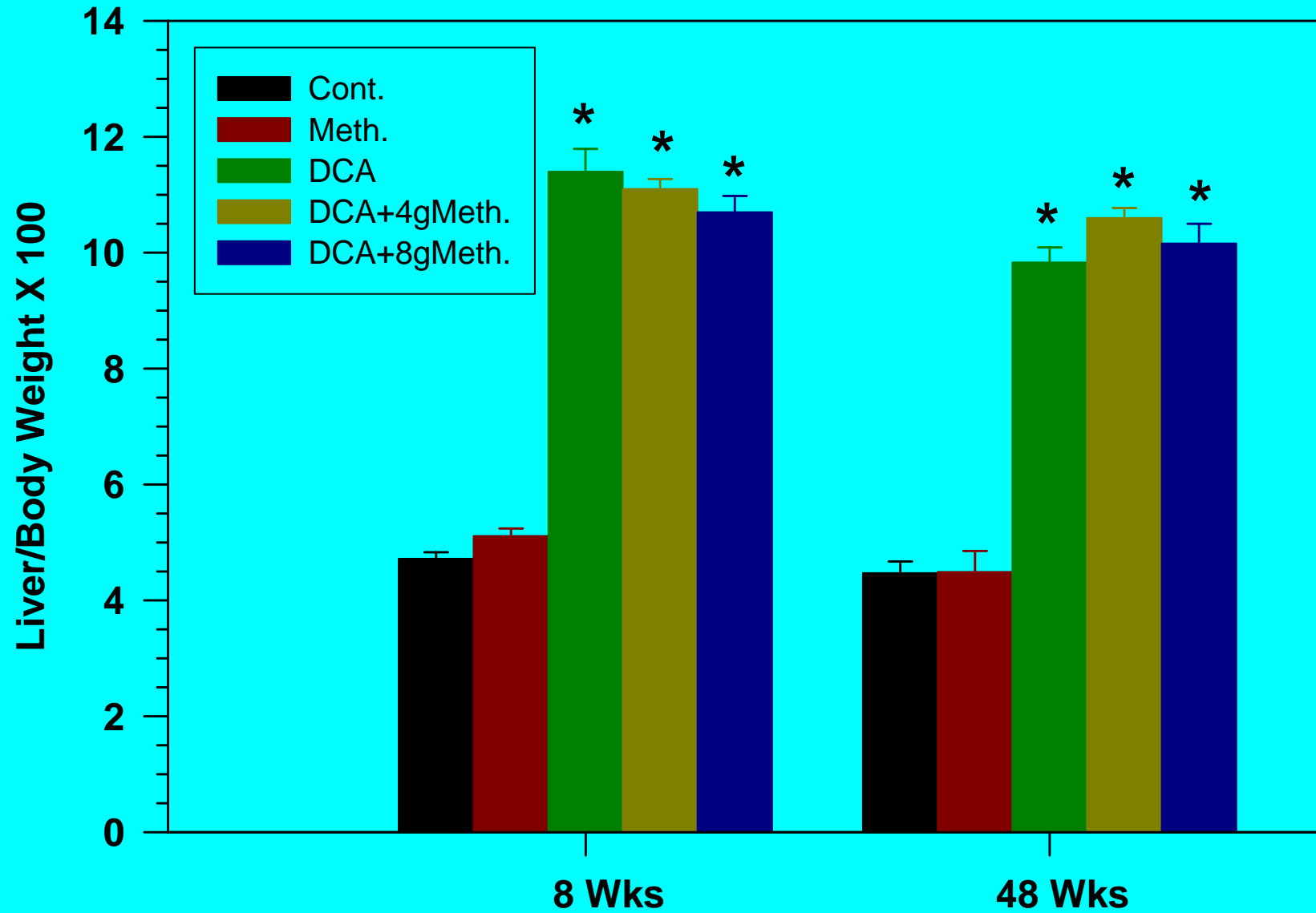

Effect of Methionine on DCA-induced Peroxisome Proliferation

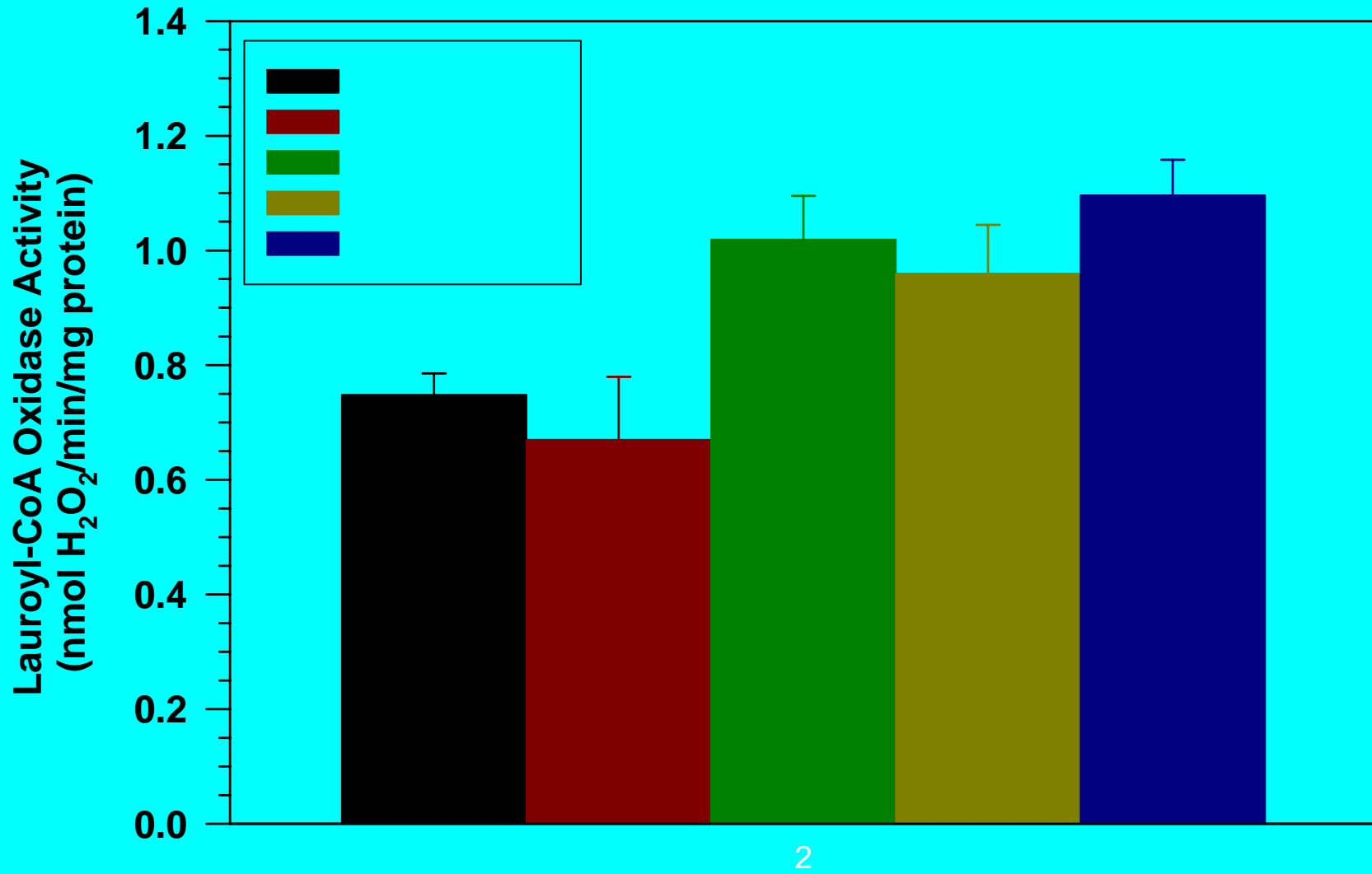

Effect of Methionine on DCA-induced Increase in Hepatic Glycogen

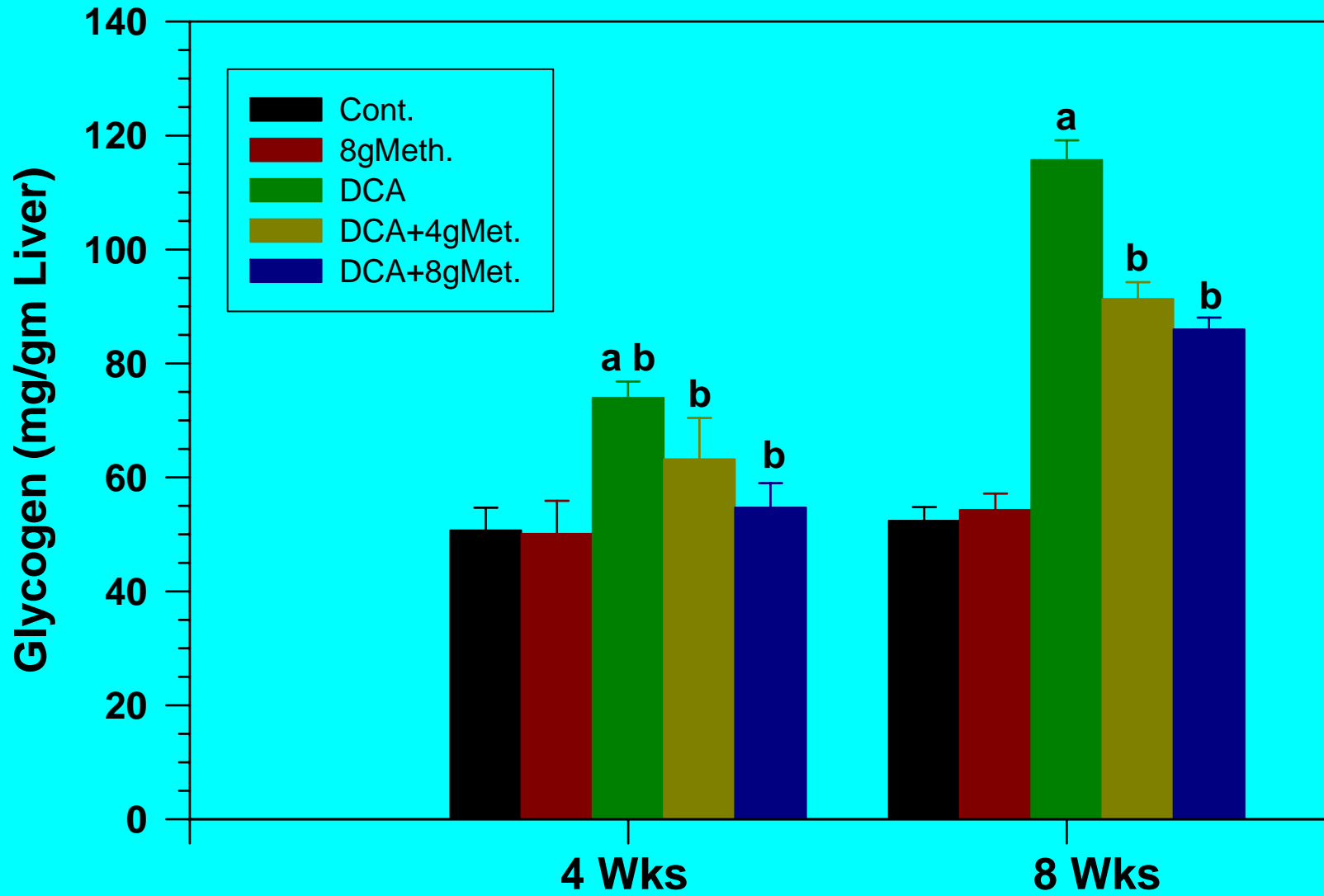

Blocking of 5-MeC Monoclonal Antibody by 5-MeC and Cytosine

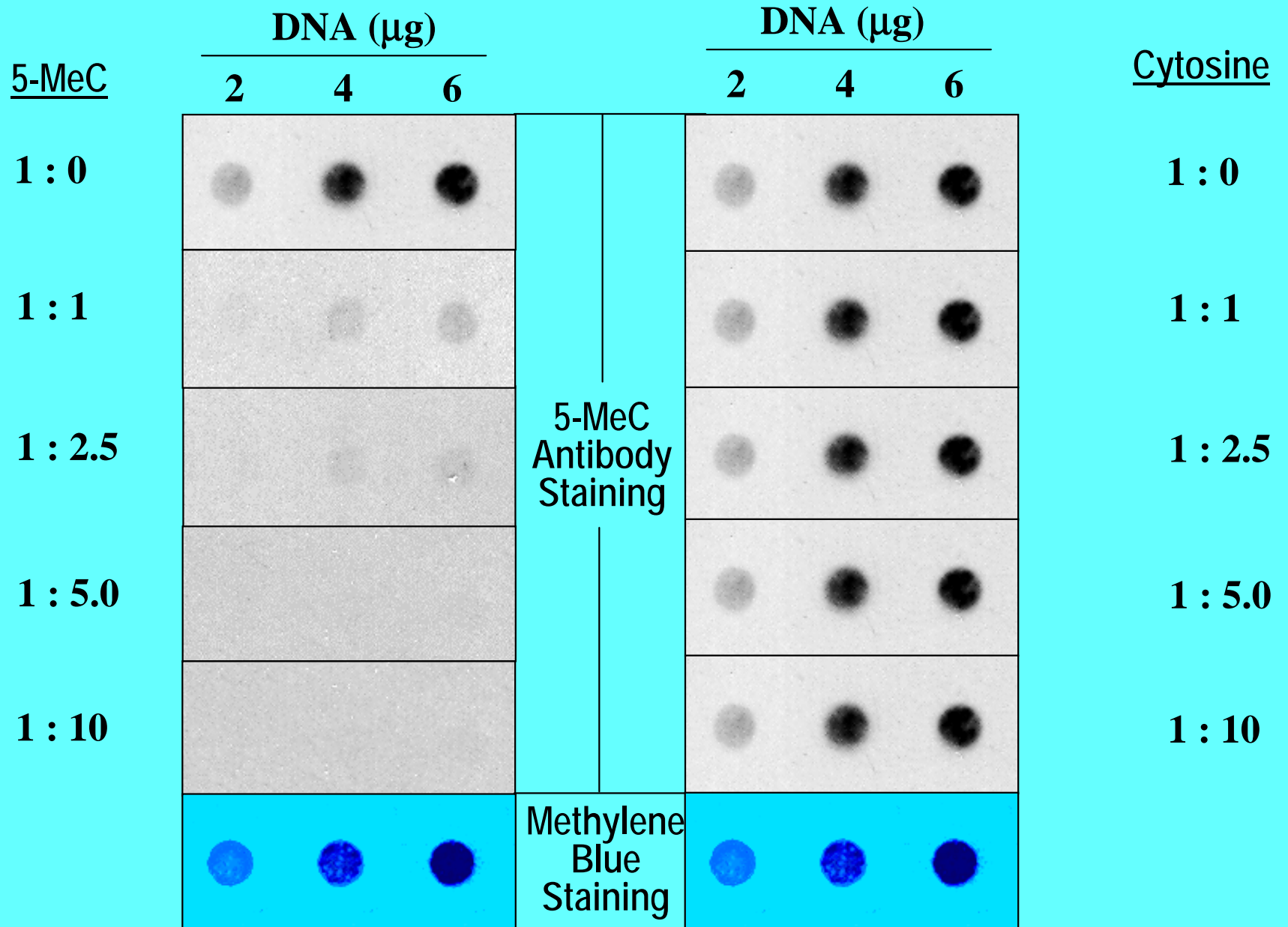

Effect of Methionine on DCA-induced DNA Hypomethylation

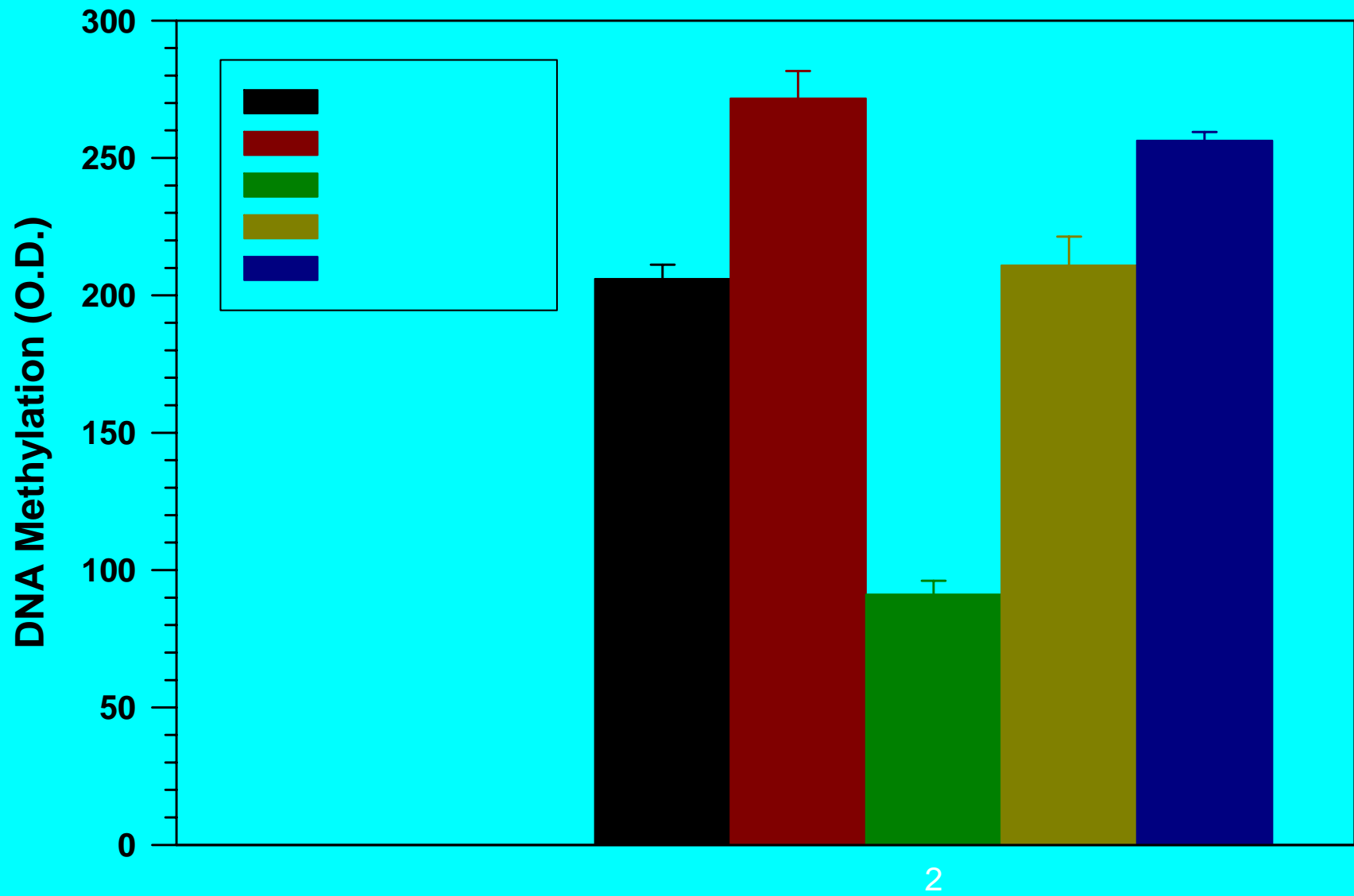

Summary: Effect of Methionine on DCA-induced DNA Hypomethylation and Mouse Liver Tumors

- 1. Methionine prevented DCA-induced DNA hypomethylation and DCA-induced Mouse Liver Tumors.**
 - 2. Methionine did not prevent DCA induction of :**
 - a. liver weight,**
 - b. peroxisomes, and**
 - c. only limitedly reduced glycogen accumulation.**
 - 3. Methionine appeared to slow the progression of foci to adenomas.**
-

Effect of Chloroform on the Carcinogenic Activity of DCA and TCA

1. Chloroform, DCA and TCA are mouse liver carcinogens found in drinking water.
 2. Possible interaction: additive, synergism, and inhibition.
 3. Parameters determined:
 - a. cell proliferation.
 - b. hypomethylation of the c-myc gene.
 - c. expression of the mRNA of the c-myc gene.
 - d. tumor response in liver and kidney.
-

Pereira, M.A., Kramer, P. M., Conran, P.B. and Tao, L. (2001). Effect of Chloroform on Dichloroacetic Acid and Trichloroacetic Acid-Induced Hypomethylation and Expression of the c-Myc Gene and on Their Promotion of Liver and Kidney Tumors in Mice. Carcinogenesis 22:1511-1519.

Effect of Chloroform on the Methylation of c-Myc Gene in Mouse Liver

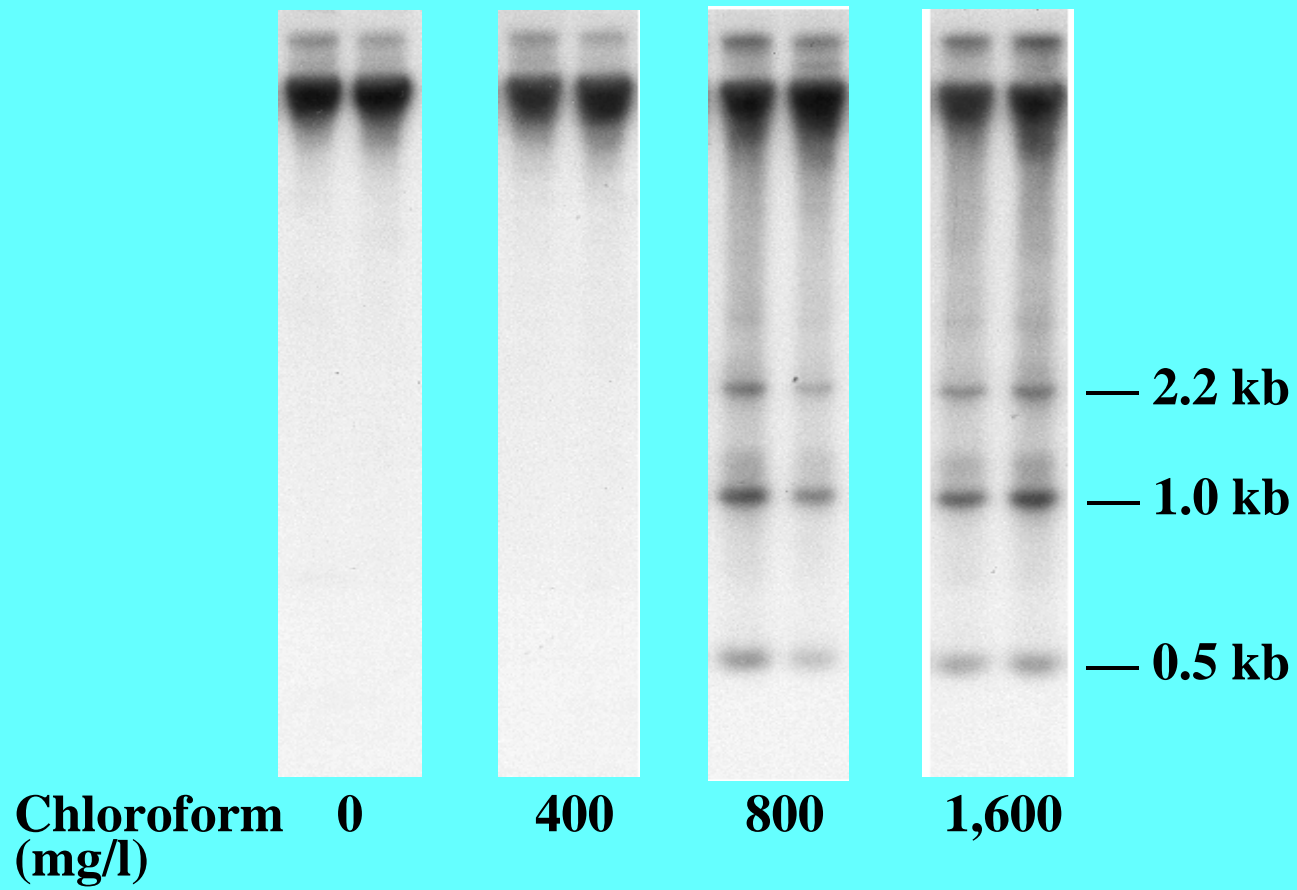

Effect of Chloroform on DCA-Induced Hypomethylation of c-Myc Gene in Mouse Liver

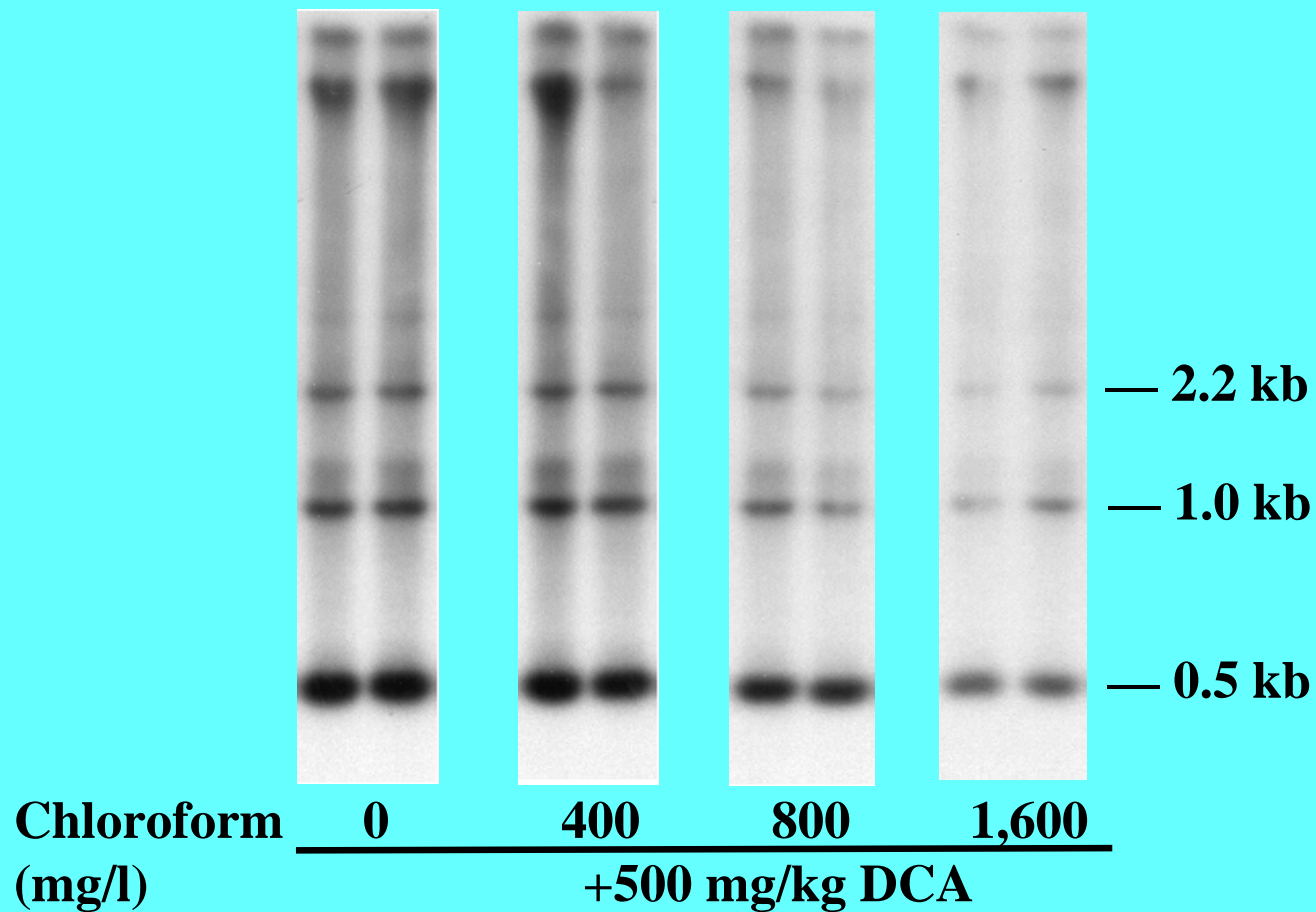

Effect of Chloroform on DCA-Induced Hypomethylation of the c-Myc Gene

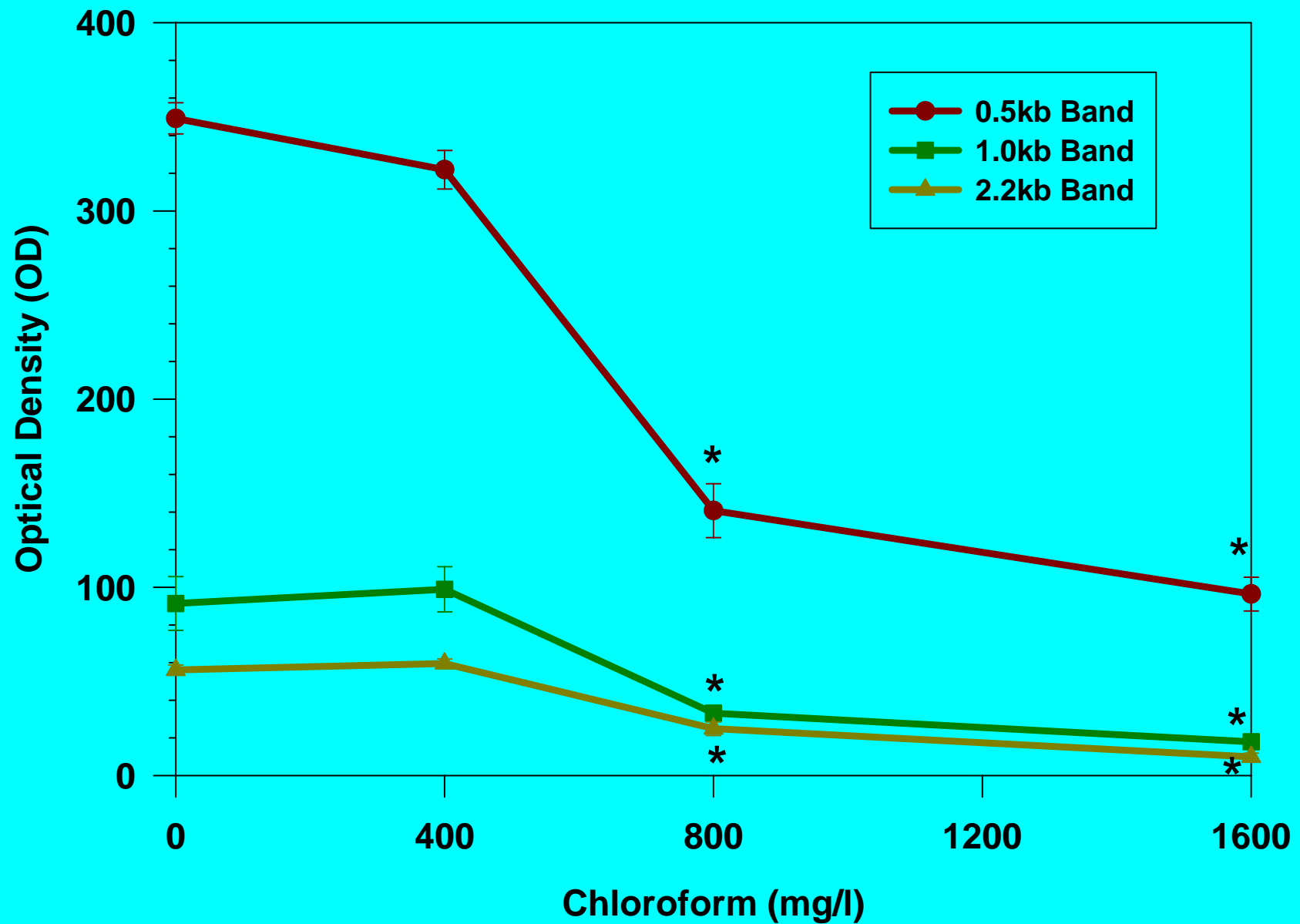

Effect of Chloroform on TCA-Induced Hypomethylation of c-Myc Gene in Mouse Liver

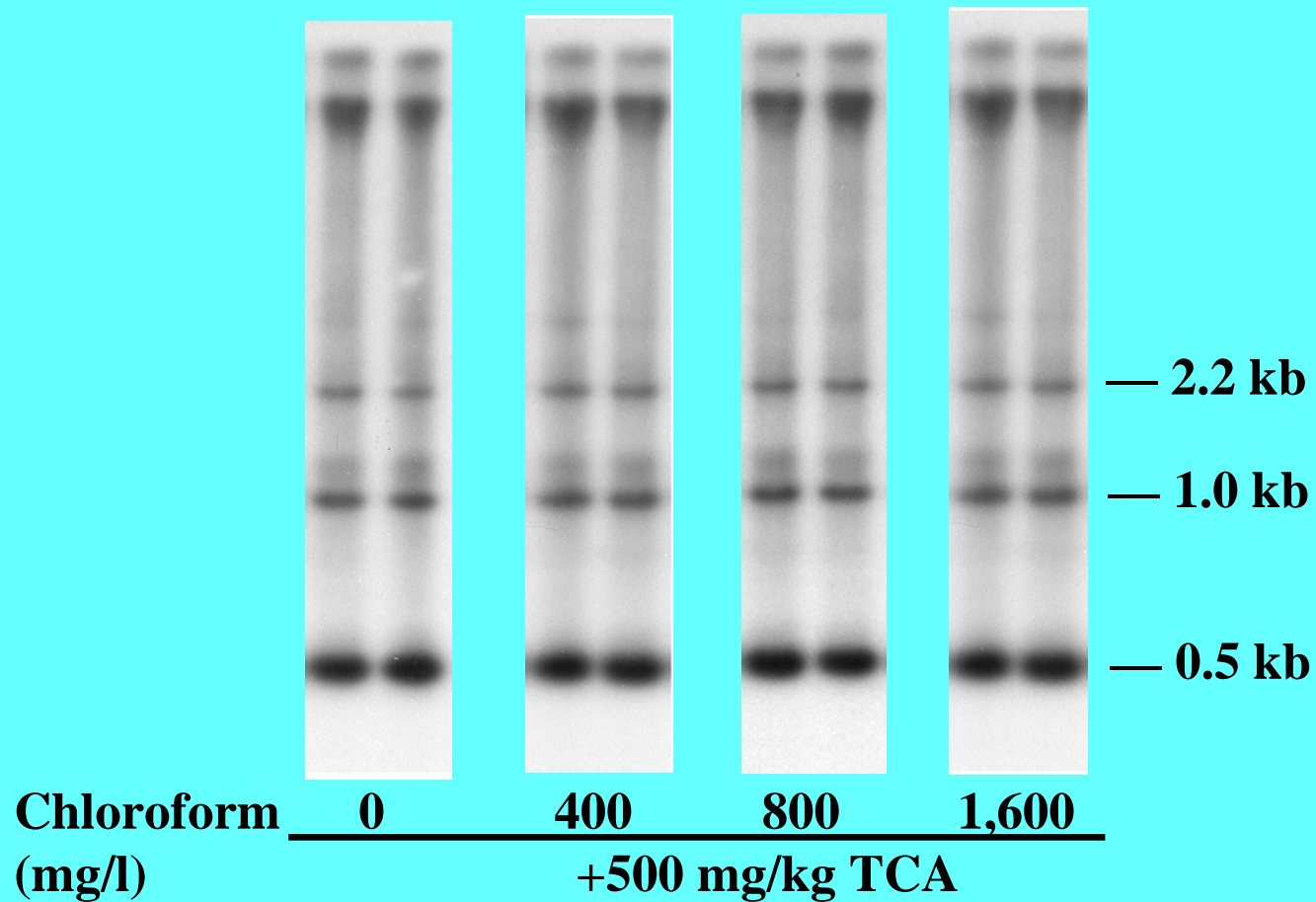

Effect of Chloroform on TCA-Induced Hypomethylation of the c-Myc Gene

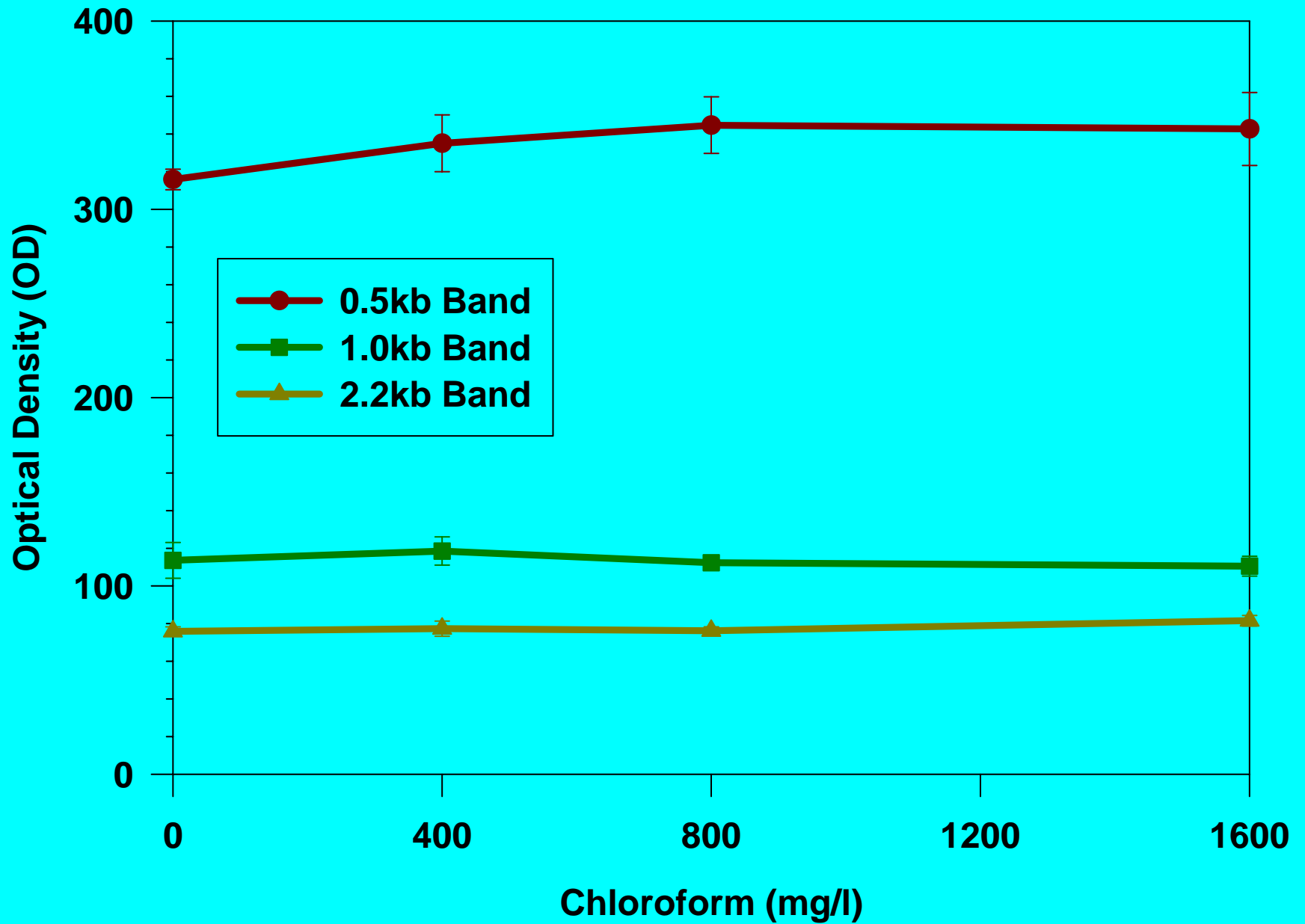

Summary of Effect of Chloroform on DCA and TCA-induced Hypomethylation

- 1. DCA and TCA decreased the methylation of the *c-myc* gene and increased its expression.**
 - 2. Although chloroform decreased the methylation of *c-myc*, it prevented DCA but TCA induced decrease in the methylation of *c-myc*.**
 - 3. Chloroform prevented DCA but not TCA increase in the expression of the *c-myc* gene.**
 - 4. DCA and TCA decreased the methylation of *c-myc* in the kidney and chloroform enhanced the ability of DCA but not TCA to decrease the methylation of the gene.**
-

Protocol for the Effect of Chloroform on the Tumor Promoting Activity of DCA and TCA in Mouse Liver

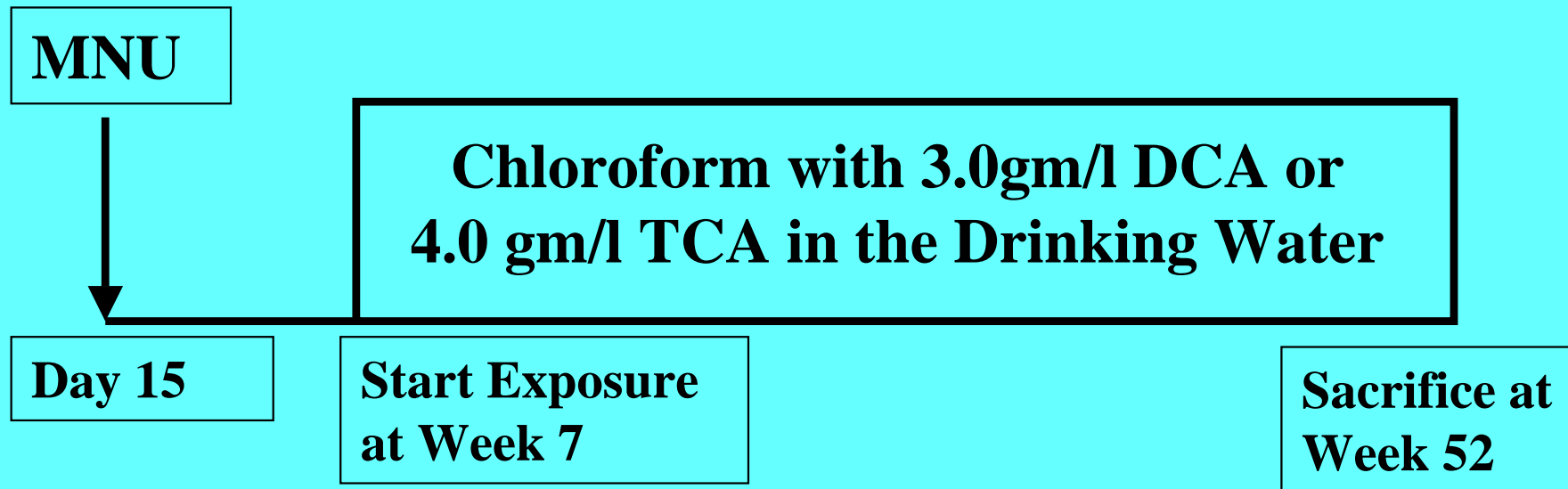

Effect of Chloroform on Liver to Body Weight Ratio in DCA and TCA-treated Female and Male B6C3F1 Mice

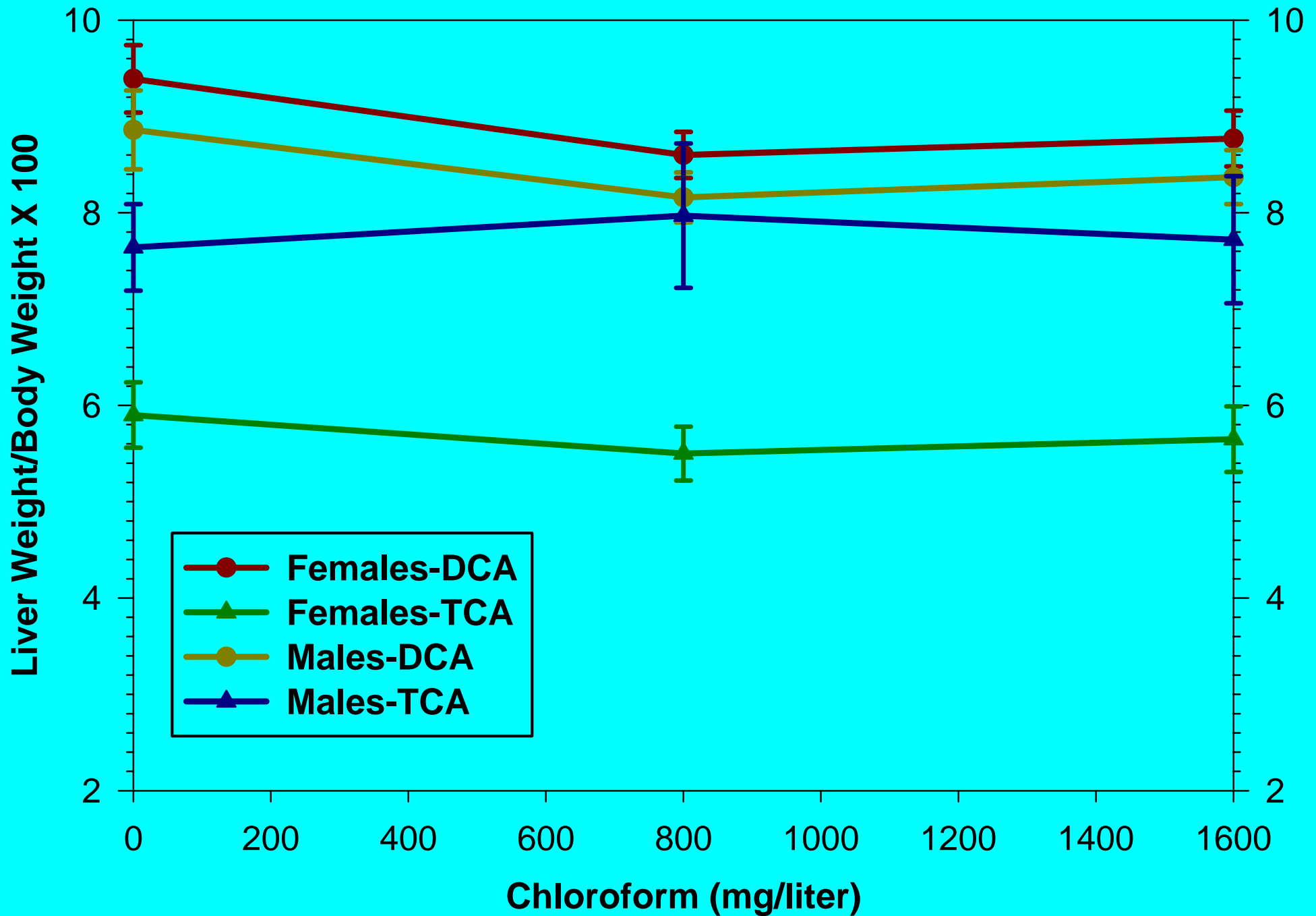

Effect of Chloroform on the Yield of Foci of Altered Hepatocytes in Female Mouse Liver

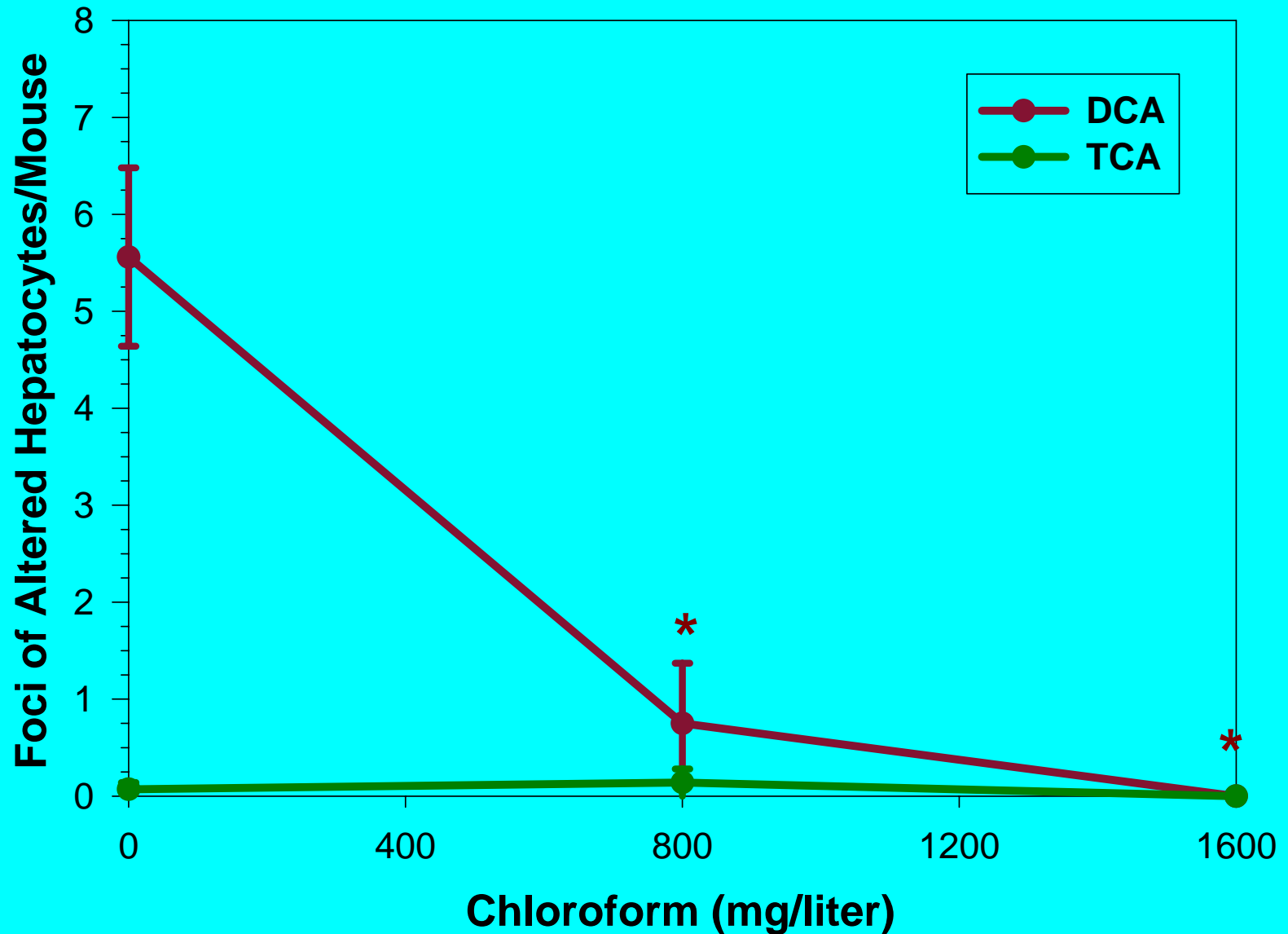

Effect of Chloroform on the Yield of Tumors in Female Mouse Liver

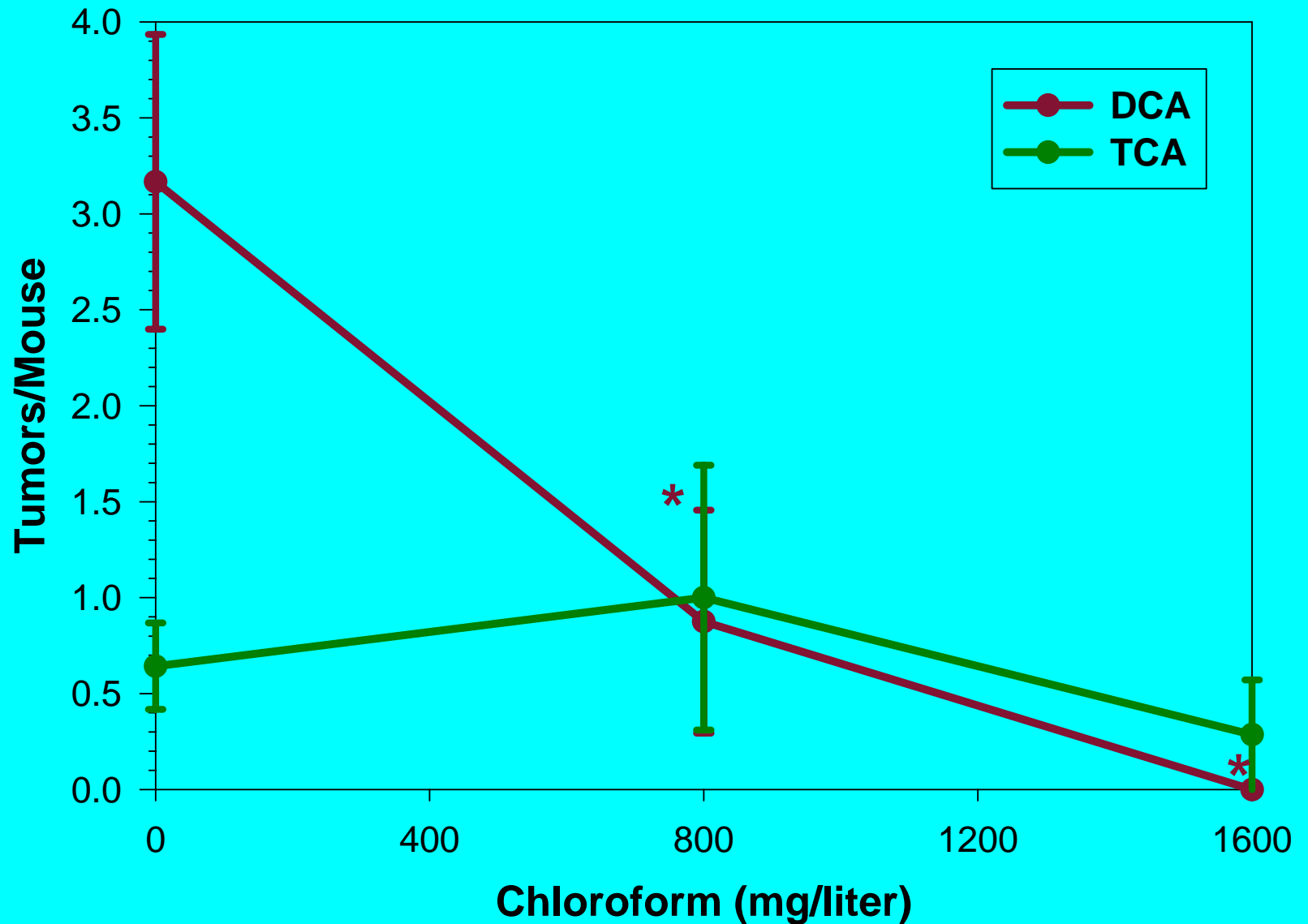

Effect of Chloroform on the Yield of Foci of Altered Hepatocytes in Male Mouse Liver

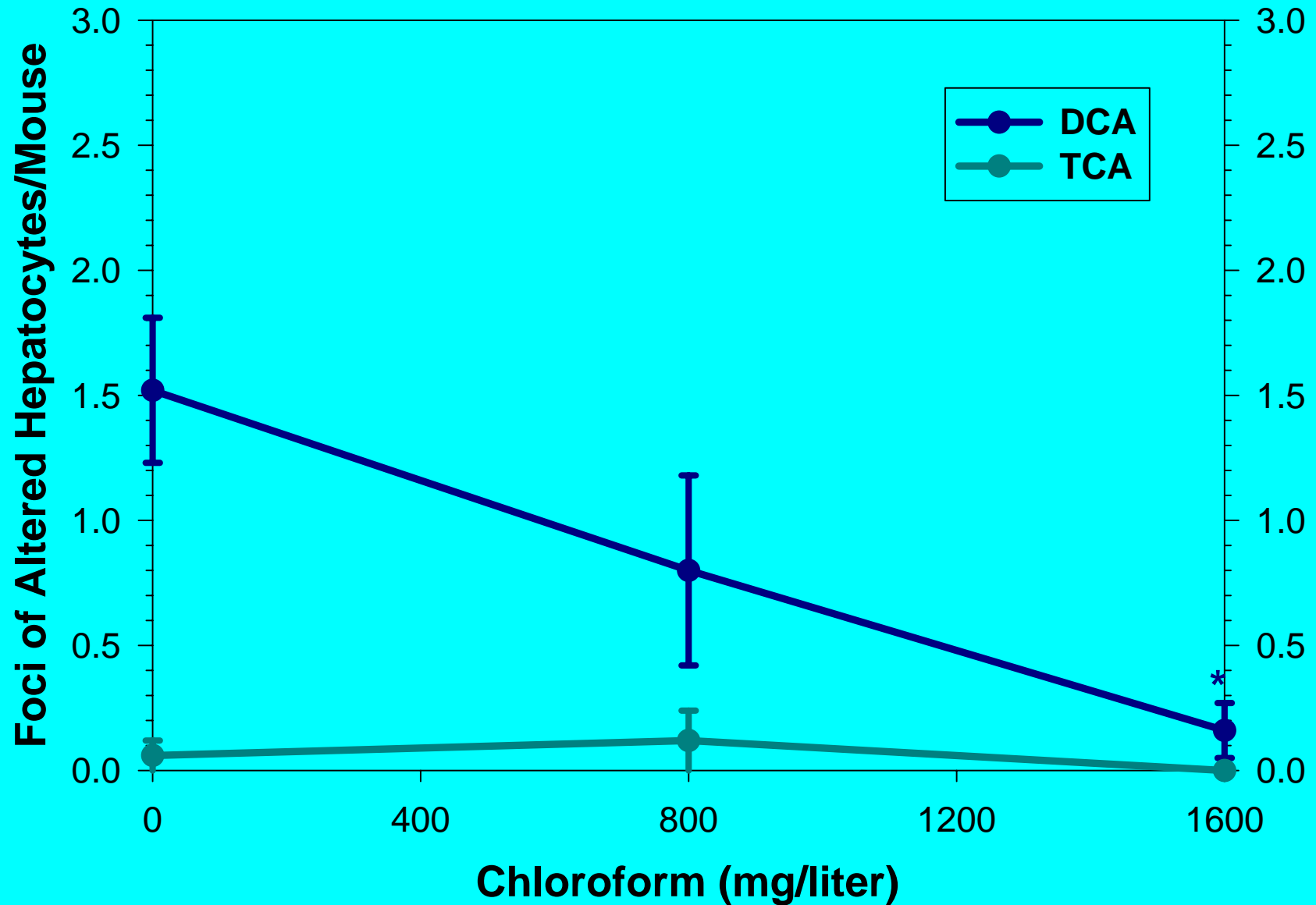

Effect of Chloroform on the Yield of Tumors in Male Mouse Liver

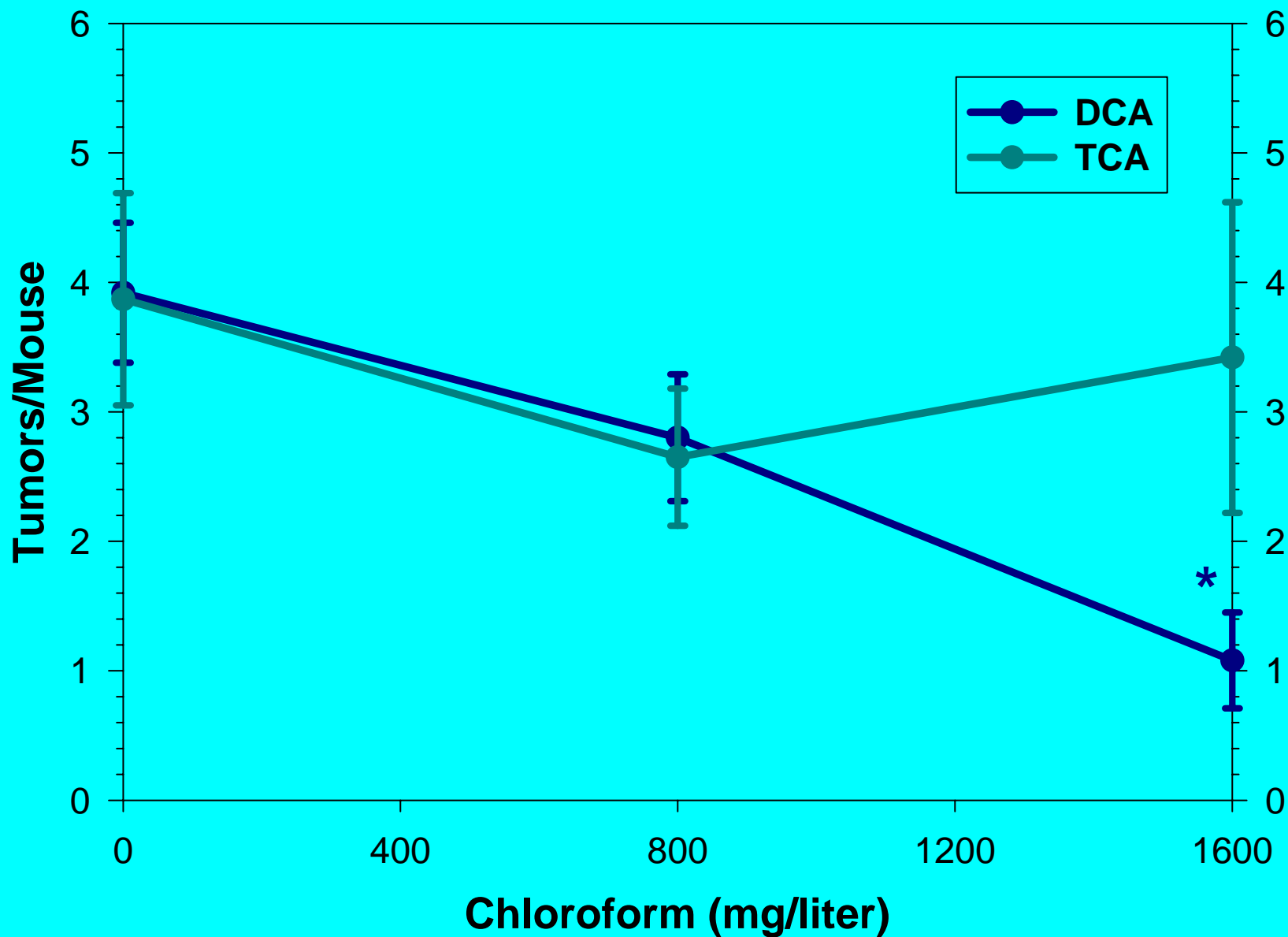

Effect of Chloroform on the Yield of Kidney Tumors in Male Mice

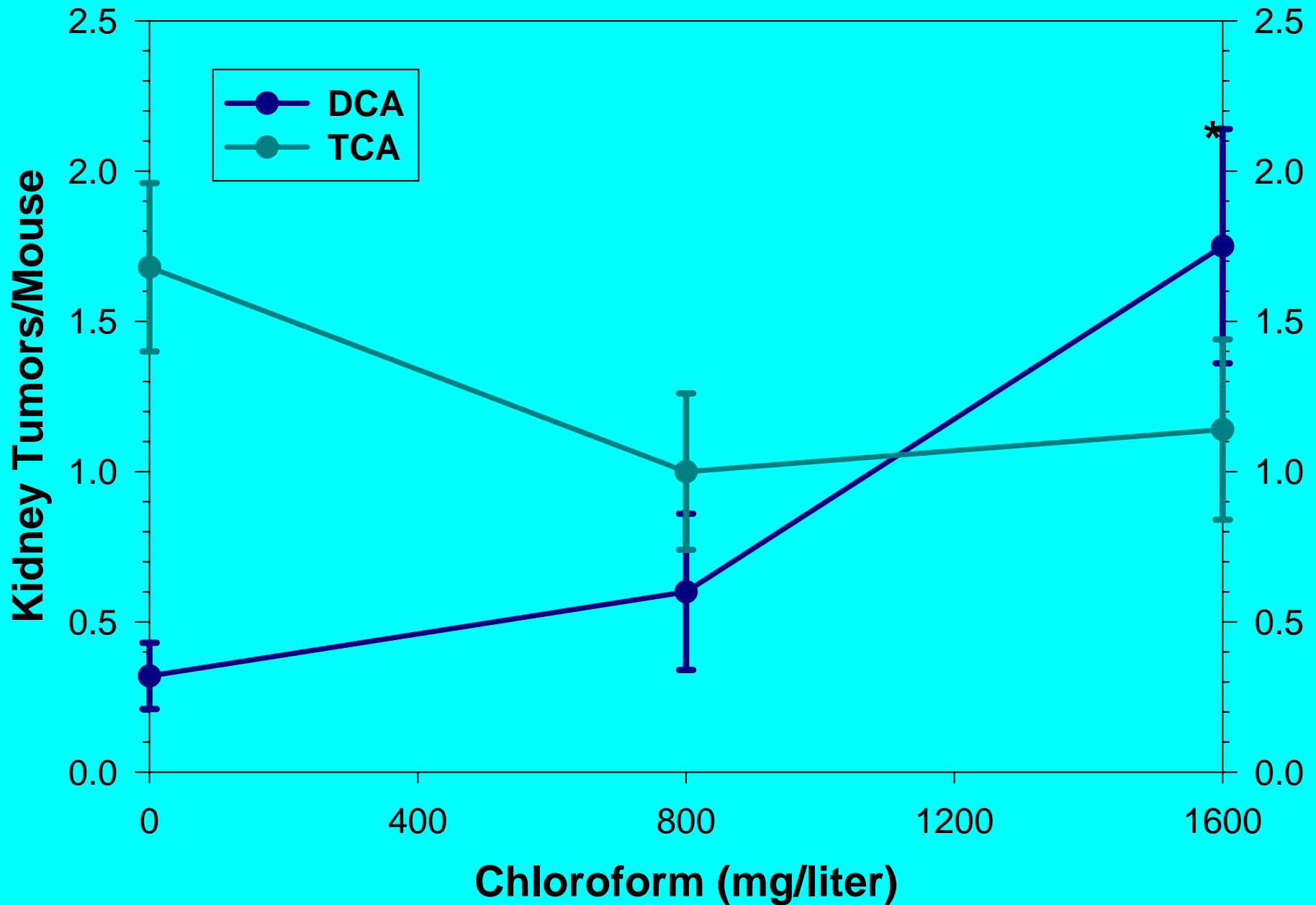

Summary of the Effect of Chloroform on the Carcinogenic Activity of DCA and TCA

- 1. Chloroform prevented the carcinogenic activity of DCA but not TCA in the liver: Correlated with Its prevention of DCA but not TCA-induced DNA Hypomethylation.**
 - 2. Chloroform did not affect the kidney tumor promoting activity of TCA while enhancing the activity of DCA.**
 - 3. In the kidney, Chloroform enhanced DCA but not TCA-induced DNA hypomethylation that correlated with its enhancement of DCA but not TCA-promotion of kidney tumors.**
-

Effect of Route of Administration on THMs Induction of DNA hypomethylation

**Coffin, J.C., Ge, R. Yang, S., Kramer, P.M., Tao, L., and Pereira, M.A. (2000)
Effect of Trihalomethanes on Cell Proliferation and DNA Methylation in Female
B6C3F1 Mouse Liver. Toxicol. Sci. 58: 243-252.**

Effect of the THM Administered by Gavage on the Methylation of the *c-myc* Promoter

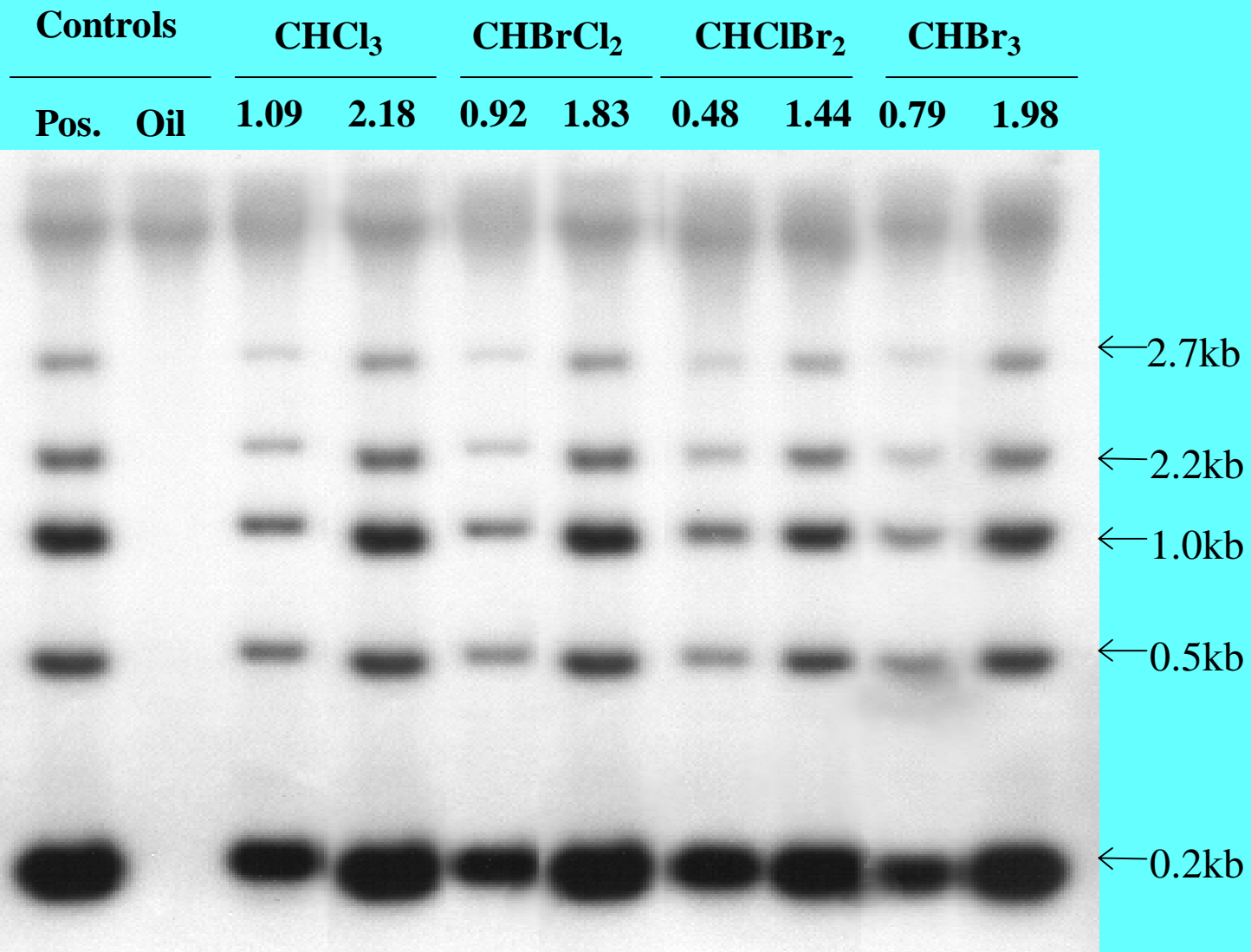

Effect of the THM Administered in the Drinking Water on the Methylation of the c-myc Promoter

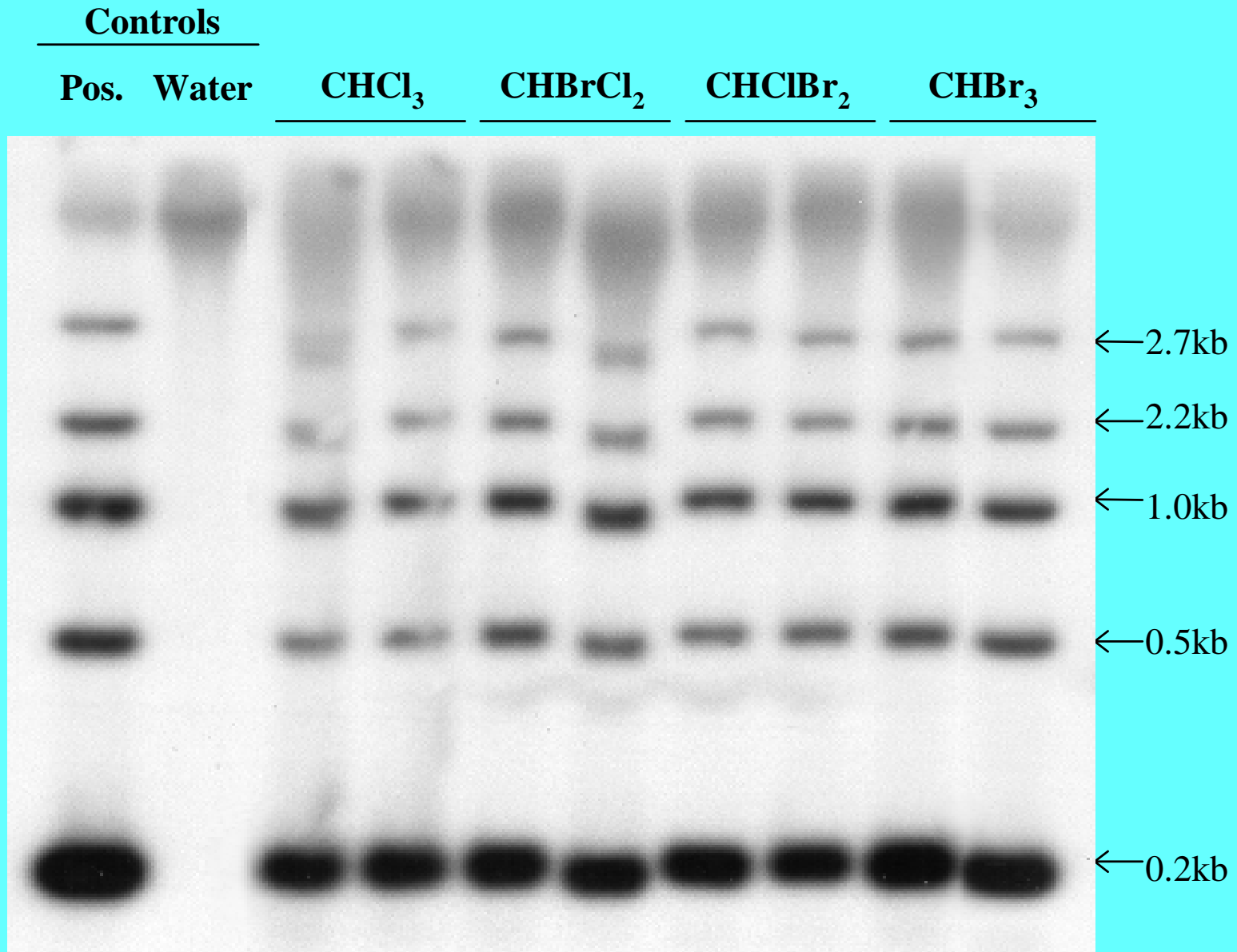

Effect of Chloroform on the Methylation of the c-Myc Gene in Mouse Liver

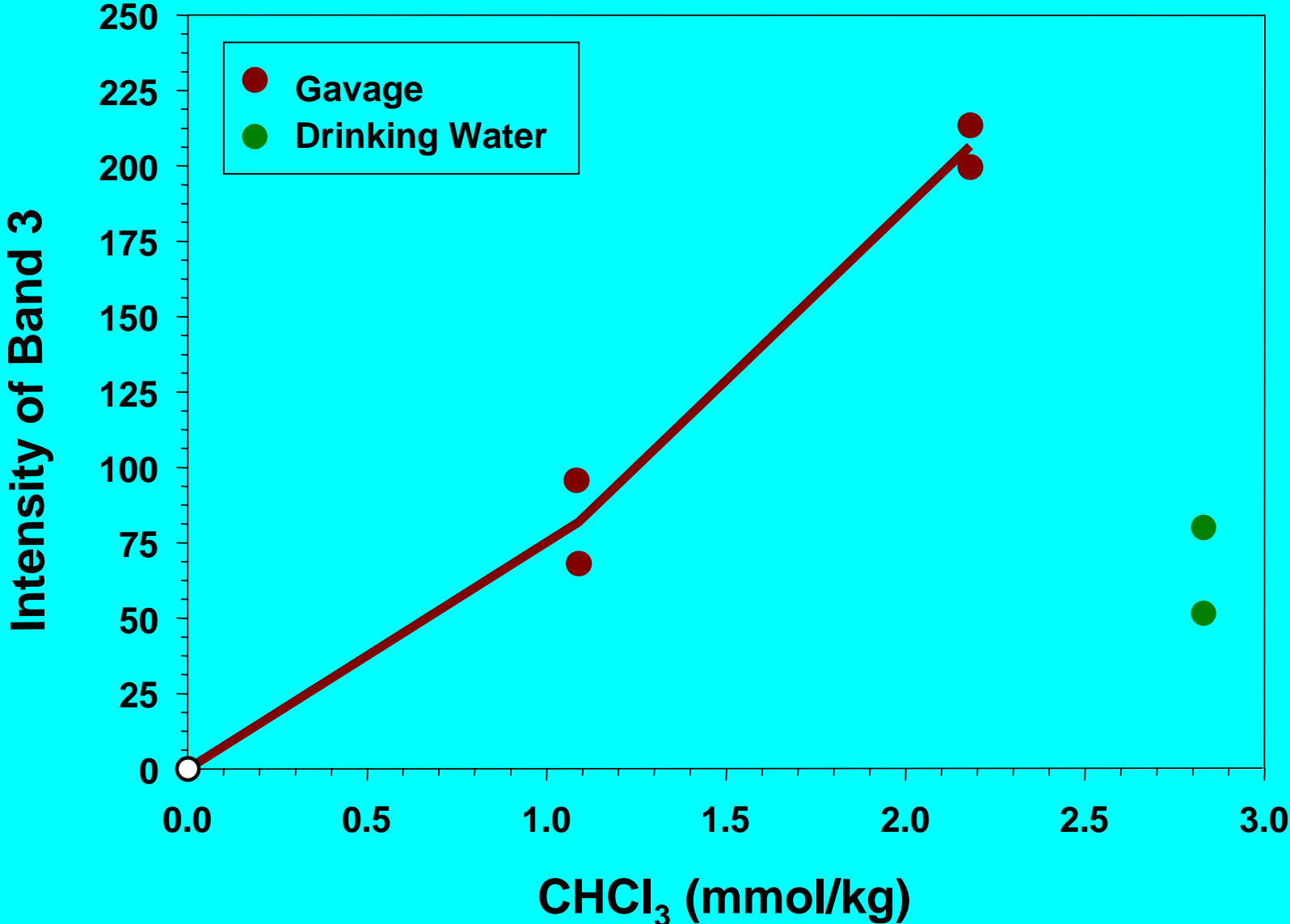

Hypermethylation of Tumor Suppressor Genes in DCA and TCA-induced Mouse Liver Tumors

1. Hypermethylation of estrogen receptor- α and *p16^{INK4A}* gene in DCA and TCA-induced mouse liver tumors.
-

Methylation of the ER- α Gene in DCA-induced Mouse Liver Tumors

	117	156	187	195	225	233	252	280	301	310	320	360	381	383	390	398	417	
Normal Live																		
6AA-1																		
6AB-1										M								
6AB-2														M				
5-48-B																		
5-49-B-2							M											
5-49-B-3																		
5-51-B																		
5-50-L-2																		
5-50-L-3																		
DCA-induced Liver Tumor																		
3-29-L-1	M											M	M	M				M
3-30-N-2		M			M	M		M			M	M	M	M		M	M	
3-30-N-4	M				M	M	M		M		M	M		M	M	M	M	
M1-30R-1	M		M		M	M	M	M				M	M	M				
3-32-N			M					M				M	M	M	M	M	M	
3-33-L					M	M						M	M	M				M
DCA-treated Non-involved Liver																		
3-29-L																		
3-32-N																		
3-33-L																		
3-35-R-1																		
3-35-R-2					M													
	117	156	187	195	225	233	252	280	301	310	320	360	381	383	390	398	417	

Methylation of the ER- α Gene in TCA-induced Mouse Liver Tumors

	117	156	187	195	225	233	252	280	301	310	320	360	381	383	390	398	417
Normal Live																	
6AA-1																	
6AB-1										M							
6AB-2														M			
5-48-B																	
5-49-B-2							M										
5-49-B-3																	
5-51-B																	
5-50-L-2																	
5-50-L-3																	
TCA-induced Liver Tumor																	
245-2	M											M	M	M			M
270-1												M	M	M	M	M	M
287-1					M	M								M		M	M
264-2					M			M				M	M	M	M		M
14-1	M		M		M	M						M		M		M	M
14-2	M		M										M	M	M	M	
14-3	M				M	M		M			M		M	M			M
142-1						M						M	M	M			M
142-2	M					M						M	M	M	M	M	M
TCA-treated Non-involved Liver																	
171-1																	
173-1	M				M									M			
221-2							M										
221-3																	
	117	156	187	195	225	233	252	280	301	310	320	360	381	383	390	398	417

Methylation of the p16 Gene in DCA-induced Mouse Liver Tumors

	26	47	67	106	119	130	141	193	222	287	299	389	397	405	420	422	431	437	468	491	494	505	516	537	545	552	557	567	571	578			
Normal Liver																																	
6AA					M																				M								
6AB																																	
5-48-B							M																										
5-49-B																						M											
DCA-induced Liver Tumor																																	
3-29-L																	M													M	M		
3-30-N												M																					
M1-30-R					M																M	M											
3-32-N																							M	M									
3-33-L																																	
DCA-treated Non-involved Liver																																	
3-29-L																						M			M								
3-32-N																					M								M				
3-33-L			M									M					M																
3-35-R																																	
	26	47	67	106	119	130	141	193	222	287	299	389	397	405	420	422	431	437	468	491	494	505	516	537	545	552	557	567	571	578			

Methylation of the p16 Gene in TCA-induced Mouse Liver Tumor

	26	47	67	106	119	130	141	193	222	287	299	389	397	405	420	422	431	437	468	491	494	505	516	537	545	552	557	567	571	578			
Normal Liver																																	
6AA					M																				M								
6AB																																	
5-48-B							M																										
5-49-B																						M											
TCA-induced Liver Tumor																																	
245																				M	M												
270																							M		M								
287																			M														
14-2																			M										M				
142-1												M														M	M						
264-1												M														M	M						
TCA-treated Non-involved Liver																																	
171-1													M																				
173-1																																	
221-1												M														M	M						
	26	47	67	106	119	130	141	193	222	287	299	389	397	405	420	422	431	437	468	491	494	505	516	537	545	552	557	567	571	578			

Mechanism of TCE, DCA and TCA Carcinogenic Activity

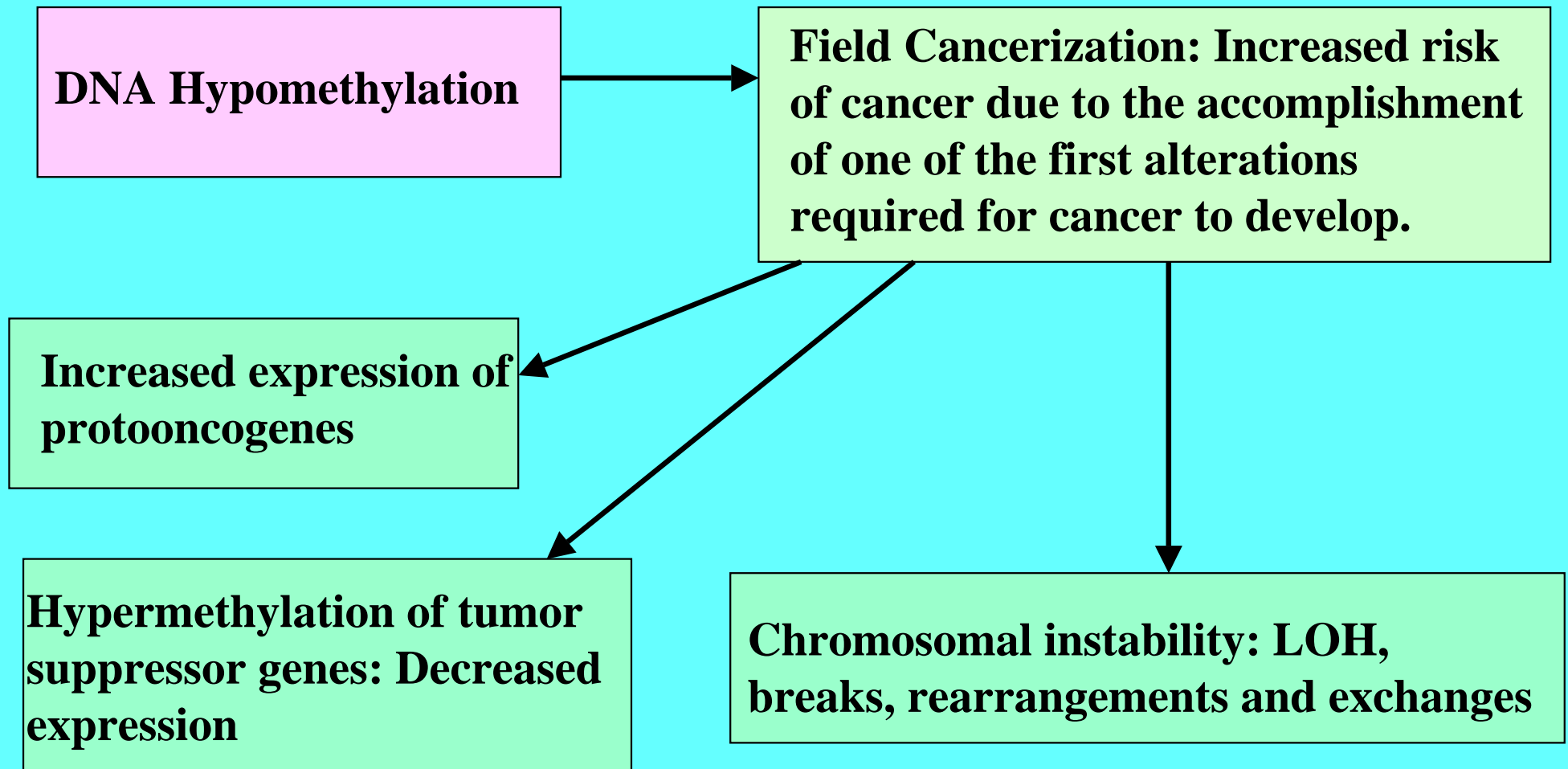

CONCLUSIONS

- 1. The mechanism of DCA and TCA carcinogenic activity could be explained by their ability to induce DNA hypomethylation and thus increase the risk of cancer.**
 - 2. Hypermethylation of tumor suppressor genes is involved in DCA and TCA carcinogenic activity.**
-

Co-Investigators

Dr. Lianhui Tao

Post-Doctoral Fellows

Dr. Wei Wang

Dr. Siming Yang

Graduate Students

Fadel S. Alyaqoub

Rungrung Ge

Long Li

Research Associates

Ms. Paula M. Kramer

**Support by 2 grants from
the US EPA.**

Multistage Model of Microsatellite Unstable Colon Carcinogenesis including Hereditary Nonpolyposis Colorectal Cancer (HNPCC)

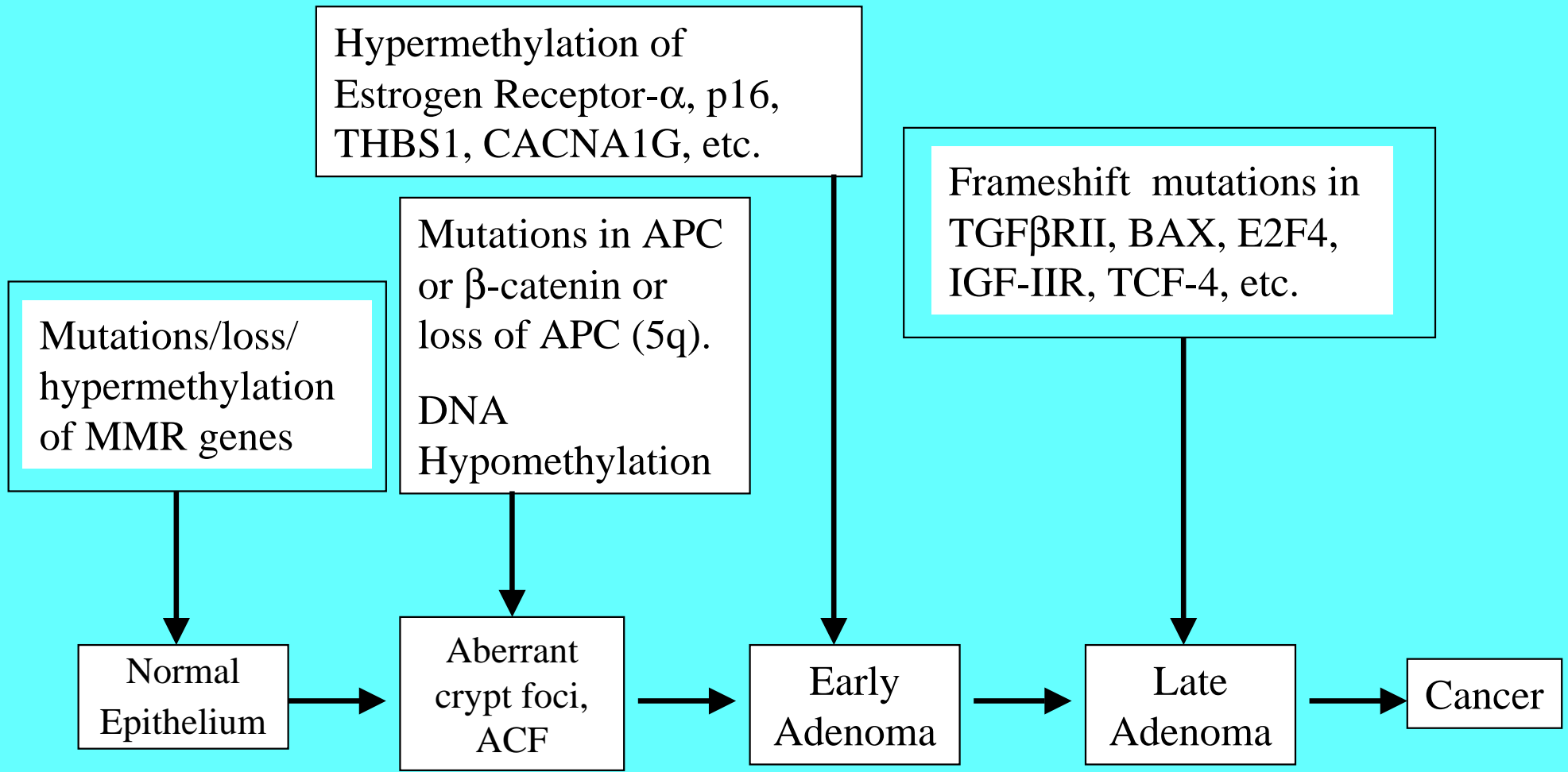

Effect of Chloroform on DCA and TCA-Induced Expression of the mRNA of the *c-Myc* Gene

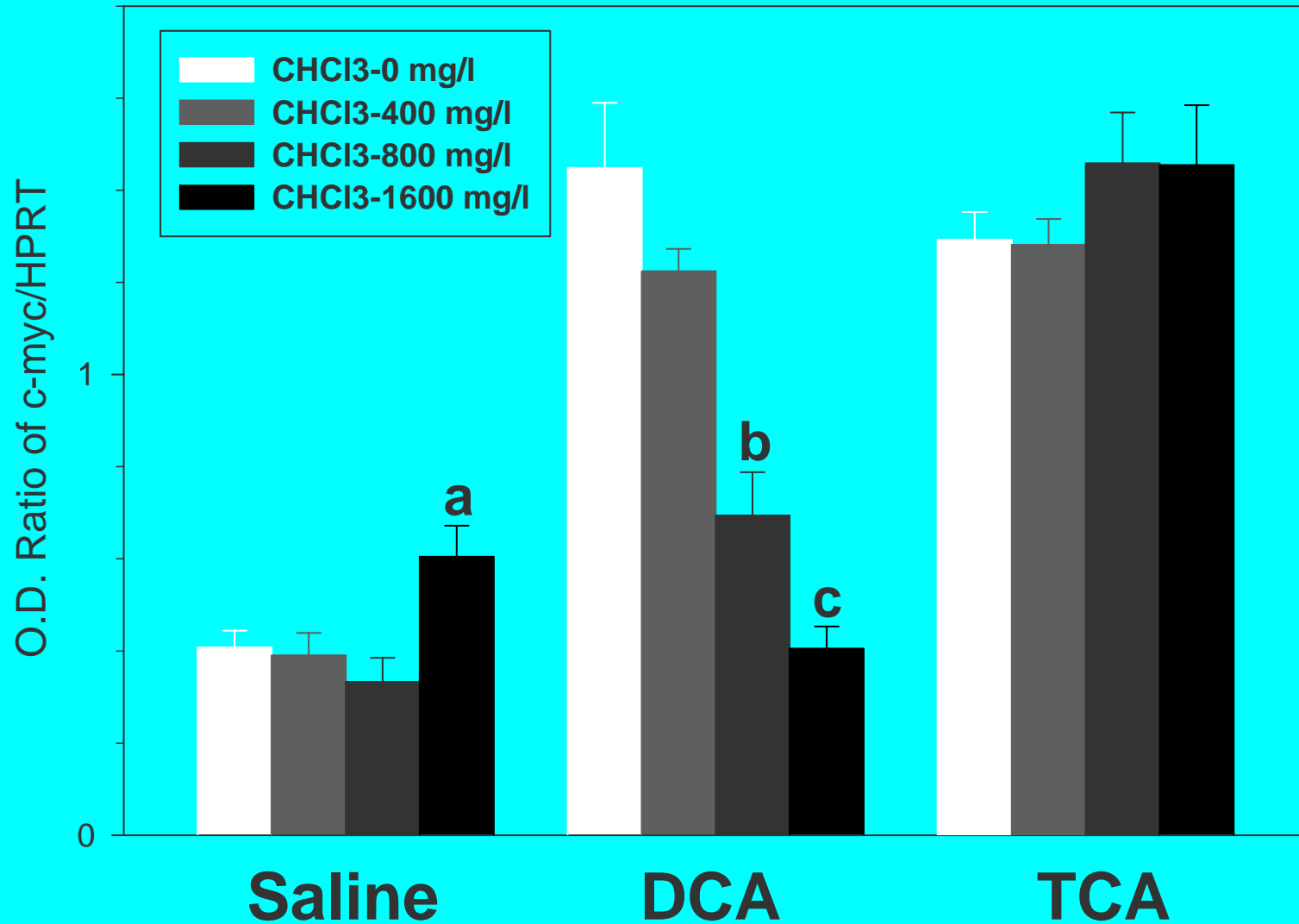

Effect of Chloroform on DCA and TCA-induced Cell Proliferation: PCNA-Labeling Index

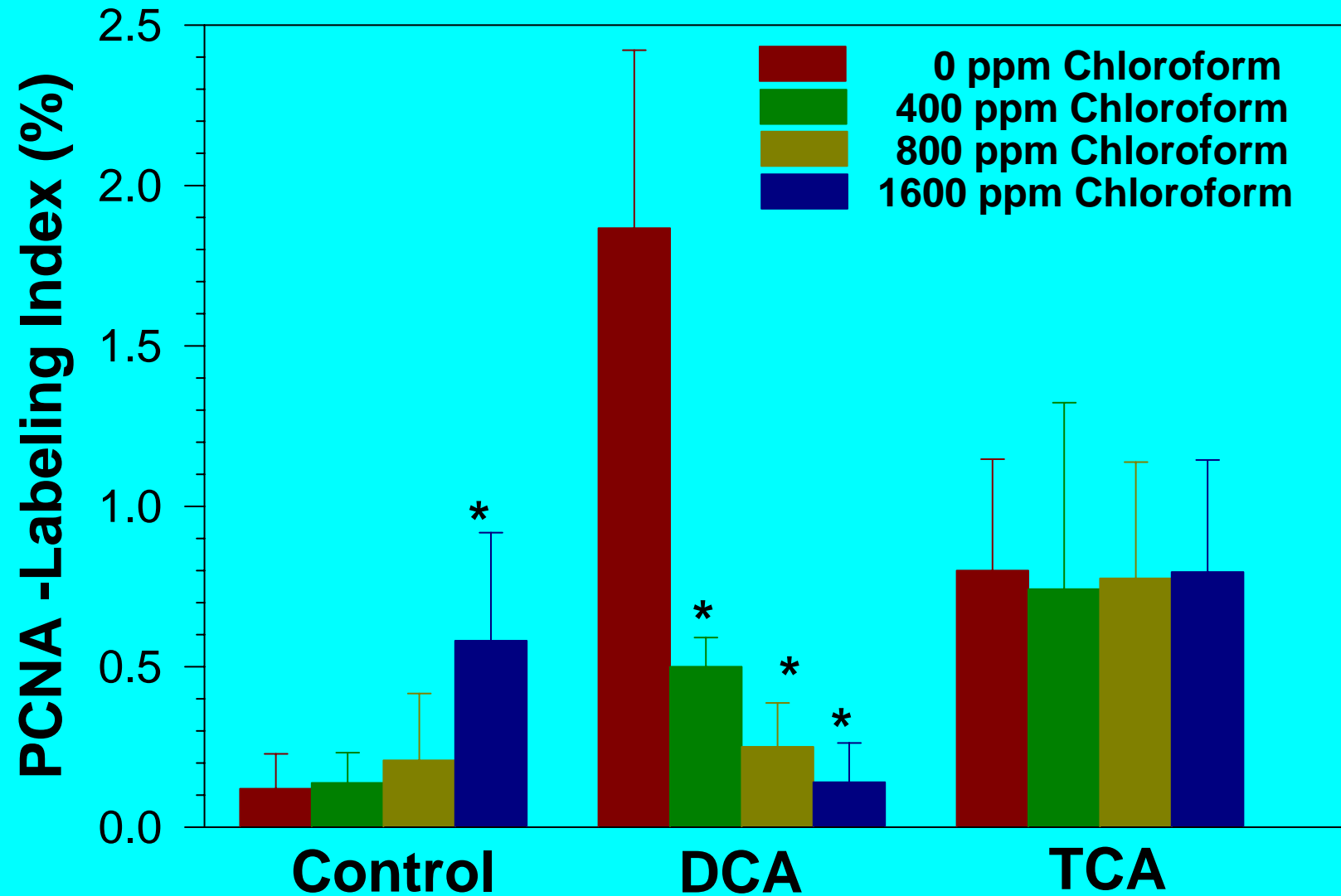

DNA Methylation

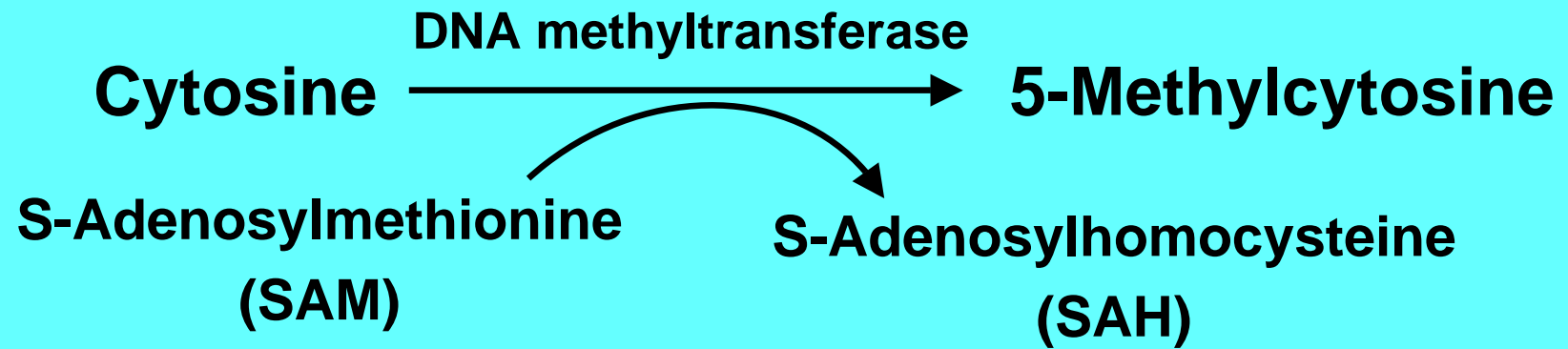

Effect of BDCM on the Methylation of the c-Myc Gene in Mouse Liver

